



# T600e/T600

Walk-Behind Floor Scrubber

English **EN**  
Operator Manual



*Hygenic*<sup>®</sup> Fully Cleanable Recovery Tank  
*Tennant True*<sup>®</sup> Parts  
*IRIS*<sup>®</sup> a Tennant Technology  
*Pro-Panel*<sup>®</sup> Controls  
*Insta-Fit*<sup>™</sup> Adapter  
*Smart-Fill*<sup>™</sup> Automatic Battery Watering



**North America / International**



For the latest Parts manuals and other  
language Operator manuals, visit:

[www.tennantco.com/manuals](http://www.tennantco.com/manuals)

9016600  
Rev. 01 (03-2018)



---

## INTRODUCTION

---

This manual is furnished with each new model. It provides necessary operation and maintenance instructions.



**Read this manual completely and understand the machine before operating or servicing it.**

This machine will provide excellent service. However, the best results will be obtained at minimum costs if:

- The machine is operated with reasonable care.
- The machine is maintained regularly - per the maintenance instructions provided.
- The machine is maintained with manufacturer supplied or equivalent parts.

To view, print or download manuals online visit [www.tennantco.com/manuals](http://www.tennantco.com/manuals)



### PROTECT THE ENVIRONMENT

Please dispose of packaging materials and used machine components such as batteries in an environmentally safe way according to your local waste disposal regulations.



Always remember to recycle.

**Tennant Company**  
**PO Box 1452**  
**Minneapolis, MN 55440**  
**Phone: (800) 553- 8033**

[www.tennantco.com](http://www.tennantco.com)

1-STEP, Pro-Membrane, Severe Environment, Zone Settings and Quiet-Mode are trademarks of Tennant Company.

Trojan and HydroLINK are registered trademarks of Trojan Battery Company.

This product may contain portions of software that have various 3<sup>rd</sup> party licenses. More information can be found at: [www.tennantco.com/opensource](http://www.tennantco.com/opensource)

Specifications and parts are subject to change without notice.

Original Instructions. Copyright ©2018 Tennant Company. All rights reserved.

---

## INTENDED USE

---

The T600e/T600 walk-behind floor scrubber is intended for commercial use, for example in hotels, schools, hospitals, factories, shops, offices and rental businesses. It is designed to scrub hard floor surfaces (concrete, tile, stone, synthetic, etc.) in an indoor environment. This machine is not intended for cleaning carpets or sanding wood floors. Use only recommended pads/brushes and commercially available floor cleaning detergents. Do not use this machine other than described in this Operator Manual.

---

## MACHINE DATA

---

Please fill out at time of installation for future reference.

Model No. - \_\_\_\_\_

Serial No. - \_\_\_\_\_

Installation Date - \_\_\_\_\_

---

## SERIAL NUMBER LABEL LOCATION

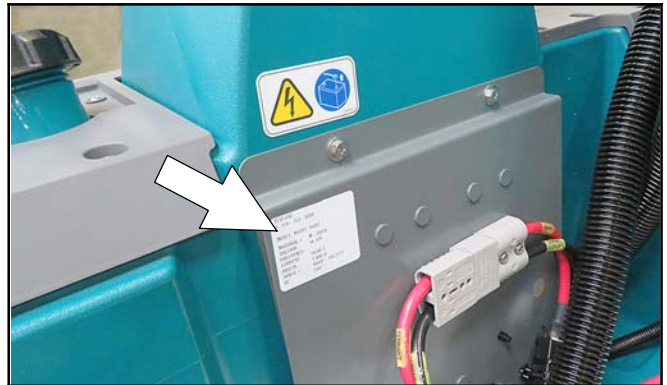

---

## UNCRATING MACHINE

---

Carefully check machine for signs of damage. Report damages at once to carrier. Contact distributor or Tennant for missing items.

To uncrate the machine, remove straps, wheel blocks and shipping brackets. Using the supplied ramp carefully back the machine off the pallet. Make sure scrub head is in the raised position.

**ATTENTION: Do not remove machine from pallet without using ramp, machine damage may occur.**

<b>INTRODUCTION</b> .....	<b>2</b>	BATTERY DISCHARGE INDICATOR ...	22
<b>INTENDED USE</b> .....	<b>2</b>	AUTOMATIC BATTERY WATERING	
<b>MACHINE DATA</b> .....	<b>2</b>	INDICATOR (Option) .....	23
SERIAL NUMBER LABEL LOCATION .....	2	T600 PRO-MEMBRANE CONTROL PANEL	23
<b>UNCRATING MACHINE</b> .....	<b>2</b>	1-STEP BUTTON .....	23
 		BRUSH PRESSURE BUTTON .....	24
<b>SAFETY</b>		SEVERE ENVIRONMENT BUTTON	
<b>IMPORTANT SAFETY INSTRUCTIONS</b> .....	<b>5</b>	(ec-H2O Model Option) .....	24
<b>SAFETY LABELS</b> .....	<b>7</b>	QUIET-MODE BUTTON .....	24
 		PRESET ZONE CONTROL BUTTONS ..	24
<b>OPERATION</b>		ec-H2O INDICATOR (Option) .....	25
<b>MACHINE COMPONENTS</b> .....	<b>8</b>	SERVICE INDICATOR .....	25
MACHINE COMPONENTS .....	9	BATTERY DISCHARGE INDICATOR ...	25
SCRUB HEAD TYPES .....	9	AUTOMATIC BATTERY WATERING	
<b>CONTROL PANEL COMPONENTS</b> .....	<b>10</b>	INDICATOR (Option) .....	26
T600e CONTROL PANEL MODEL .....	10	SPRAY NOZZLE INDICATOR (T600 Option)	26
T600 PRO-MEMBRANE CONTROL PANEL		T600 PRO-PANEL CONTROLS .....	27
MODEL .....	10	HOME SCREEN .....	27
T600 PRO-PANEL CONTROLS MODEL ...	11	HELP BUTTON .....	27
<b>MACHINE SYMBOLS</b> .....	<b>12</b>	LOGIN SCREEN .....	27
T600 PRO-PANEL SYMBOLS .....	12	ec-H2O INDICATOR (Option) .....	28
<b>INSTALLING BATTERIES</b> .....	<b>13</b>	1-STEP BUTTON .....	28
<b>HOW THE MACHINE WORKS</b> .....	<b>13</b>	BRUSH PRESSURE BUTTON .....	28
<b>BRUSH AND PAD INFORMATION</b> .....	<b>14</b>	SOLUTION FLOW BUTTON .....	28
<b>MACHINE SETUP</b> .....	<b>14</b>	SEVERE ENVIRONMENT BUTTON	
INSTALLING SQUEEGEE ASSEMBLY .....	14	(ec-H2O Model Option) .....	29
INSTALLING AND REMOVING DISK		MAXIMUM SCRUB SPEED BUTTON ...	29
BRUSHES/PADS (Disk Scrub Head Model)	16	QUIET-MODE BUTTON .....	29
INSTALLING ORBITAL PADS		SPRAY NOZZLE INDICATOR (T600 Option)	30
(Orbital Scrub Head Model) .....	17	BATTERY DISCHARGE INDICATOR ...	30
INSTALLING CYLINDRICAL BRUSHES		VIDEO TUTORIAL BUTTON	
(Cylindrical Brush Scrub Head Model) .....	17	(Operator Mode Home Screen) .....	30
FILLING SOLUTION TANK .....	18	PRESET ZONE CONTROL BUTTONS ..	31
USING SOLUTION TANK AUTO-FILL		SERVICE INDICATOR BUTTON .....	31
(T600 OPTION) .....	18	FAULT SCREENS .....	32
FILLING SEVERE ENVIRONMENT DETERGENT		MACHINE SETTINGS BUTTON .....	33
TANK (T600 ec-H2O MODEL OPTION) ....	19	<b>MACHINE OPERATION</b> .....	<b>34</b>
ec-H2O WATER CONDITIONING CARTRIDGE		PRE-OPERATION CHECK LIST .....	34
(ec-H2O MODEL) .....	20	OPERATING MACHINE .....	34
FILLING AUTOMATIC BATTERY WATERING		DOUBLE SCRUBBING .....	35
TANK (OPTION) .....	20	EMERGENCY SHUT-OFF BUTTON .....	36
ACCESSORY RAILS .....	21	OPERATING SPRAY NOZZLE (T600 Option)	36
<b>CONTROL PANEL OPERATION</b> .....	<b>21</b>	WHILE OPERATING MACHINE .....	36
T600e CONTROL PANEL .....	21	CIRCUIT BREAKER PANEL .....	37
1-STEP BUTTON .....	21	HOUR METER .....	37
BRUSH PRESSURE BUTTON .....	21	<b>DRAINING TANKS</b> .....	<b>37</b>
SOLUTION FLOW BUTTON .....	22	DRAINING RECOVERY TANK .....	37
ec-H2O INDICATOR (Option) .....	22	DRAINING SOLUTION TANK .....	38
SERVICE INDICATOR .....	22		

# CONTENTS

---

<b>SERVICE INDICATOR CODES</b> .....	<b>39</b>
T600e MODEL SERVICE INDICATOR CODES	39
T600 MODEL SERVICE INDICATOR CODES	40
T600e/T600 ON-BOARD BATTERY CHARGER SERVICE INDICATOR CODES .....	42
T600e/T600 ec-H2O SYSTEM SERVICE INDICATOR CODES - OPTION .....	43

## MAINTENANCE

<b>MAINTENANCE CHART</b> .....	<b>44</b>
--------------------------------	-----------

<b>MACHINE MAINTENANCE</b> .....	<b>45</b>
YELLOW TOUCH POINTS .....	45
AFTER DAILY USE .....	45
AFTER WEEKLY USE .....	47
AFTER EVERY 50 HOURS OF USE .....	48
AFTER EVERY 100 HOURS OF USE .....	49
AFTER EVERY 200 HOURS OF USE .....	49
ELECTRIC MOTORS .....	49
BELTS (Cylindrical Brush Model) .....	49

<b>BATTERIES</b> .....	<b>50</b>
------------------------	-----------

MAINTENANCE-FREE BATTERIES .....	50
FLOODED (WET) LEAD-ACID BATTERIES	50
CHECKING CONNECTIONS / CLEANING ..	50
CHARGING BATTERIES .....	51
BATTERY CHARGER SETTINGS .....	52
OFF-BOARD BATTERY CHARGER SETTINGS: .....	52
SELECTING BATTERY TYPE (T600 Pro-Panel model) .....	53
HYDROLINK® BATTERY WATERING SYSTEM (Trojan® Battery OPTION) .....	54
AUTOMATIC BATTERY WATERING SYSTEM (Trojan® Battery OPTION) .....	55
BATTERY COMPARTMENT DRAIN HOSE .	55

<b>SQUEEGEE BLADE REPLACEMENT</b> .....	<b>56</b>
---	-----------

<b>ec-H2O WATER CONDITIONING CARTRIDGE REPLACEMENT</b> .....	<b>57</b>
--	-----------

<b>MACHINE JACKING</b> .....	<b>58</b>
------------------------------	-----------

<b>PUSHING AND TRANSPORTING MACHINE</b> ...	<b>58</b>
PUSHING MACHINE .....	58
TRANSPORTING MACHINE .....	58

<b>STORING MACHINE</b> .....	<b>59</b>
FREEZE PROTECTION .....	59

<b>TROUBLESHOOTING</b> .....	<b>60</b>
------------------------------	-----------

## SPECIFICATIONS

<b>GENERAL MACHINE DIMENSIONS/CAPACITIES/PERFORMANCE</b> .	<b>62</b>
<b>MACHINE DIMENSIONS</b> .....	<b>64</b>

## SUPERVISOR CONTROLS

<b>SUPERVISOR CONTROLS</b> .....	<b>67</b>
T600e MODEL .....	67
T600 PRO-MEMBRANE CONTROL PANEL MODEL .....	68
T600 PRO-PANEL CONTROLS MODEL ...	69
To Add/Edit User Profiles .....	70
Enabling the Login Screen .....	72
Disabling the Login Screen .....	73
Changing the Factory-Assigned Supervisor Login Code .....	74

---

## IMPORTANT SAFETY INSTRUCTIONS - SAVE THESE INSTRUCTIONS

---

The following warning precautions are used throughout this manual as indicated in their description:

**⚠ WARNING:** To warn of hazards or unsafe practices which could result in severe personal injury or death.

**FOR SAFETY:** To identify actions which must be followed for safe operation of equipment.

The following information signals potentially dangerous conditions to the operator. Know when these conditions can exist. Locate all safety devices on the machine. Report machine damage or faulty operation immediately.

**⚠ WARNING:** To Reduce the Risk of Fire, Explosion, Electric Shock or Injury:

- Read manual before operating machine.
- Do not use or pick up flammable materials or reactive metals.
- Do not use near flammable liquids, vapors or combustible dusts.  
This machine is not equipped with an explosion proof motor. The electric motor will spark upon start up and during operation which could cause a flash fire or explosion if machine is used in an area where flammable vapors/liquids or combustible dusts are present.
- Batteries emit hydrogen gas. Explosion or fire can result. Keep sparks and open flame away when charging.
- Disconnect battery cables and charger cord before cleaning and servicing machine.
- Do not charge batteries with damaged cord. Do not modify plug.

If the charger supply cord is damaged or broken, it must be replaced by the manufacturer or its service agent or a similarly qualified person in order to avoid a hazard.

- Do not use outdoors. Store indoors.
- Spinning pad/brush, keep hands away.

**WARNING:** This machine contains chemicals known to the state of California to cause cancer, birth defects, or other reproductive harm.

**IRIS Telemetry (Option) -** This machine may be equipped with technology that automatically communicates over the cellular network. If the machine will be operated where cell phone use is restricted because of concerns related to equipment interference, please contact a Tennant representative for information on how to disable the cellular communication functionality.

**FOR SAFETY:**

1. Do not operate machine:
  - Unless trained and authorized.
  - Unless operator manual is read and understood.
  - Unless mentally and physically capable of following machine instructions.
  - Under the influence of alcohol or drugs.
  - While using a cell phone or other types of electronic devices.
  - If not in proper operating condition.
  - In outdoor areas. This machine is for indoor use only.
  - In areas where flammable vapors/liquids or combustible dusts are present.
  - With pads or accessories not supplied or approved by Tennant. The use of other pads may impair safety.
  - In areas with possible falling objects.
  - In areas that are too dark to safely see the controls or operate machine.
2. Before operating machine:
  - Check machine for fluid leaks.
  - Make sure all safety devices are in place and operate properly.
  - Set the directional lever before pulling start bail.
3. When operating machine:
  - Use only as described in this manual.
  - Report machine damage or faulty operation immediately.
  - Wear closed-toe, non-slip work shoes.
  - Reduce speed when turning.
  - Go slowly on inclines and slippery surfaces.
  - Always be aware of surroundings while operating machine.
  - Drive slowly through doorways and narrow openings.
  - Be cautious of the squeegee near bystanders and obstacles.
  - Do not access the video / help screens while machine is moving. (Pro-Panel)

- Do not scrub or transport on inclines that exceed 2% grade.
  - Follow site safety guidelines concerning wet floors.
  - Follow mixing, handling and disposal instructions on chemical containers.
  - Do not carry passengers on machine.
  - Use care when reversing machine.
  - Keep children and unauthorized persons away from machine.
  - Do not allow machine to be used as a toy.
  - Do not use spray nozzle for off-aisle cleaning, slip hazard may occur.
  - Do not leave machine unattended when filling solution tank with auto-fill feature.
  - Park machine on level surface when filling solution tank with auto-fill feature.
4. Before leaving or servicing machine:
- Stop on level surface.
  - Turn off machine and remove key.
5. When servicing machine:
- Disconnect battery connection and charger cord before working on machine.
  - Do not pull on battery charger cord to unplug. Grasp plug at outlet and pull.
  - All work must be done with sufficient lighting and visibility.
  - All repairs must be performed by trained personnel.
  - Use Tennant supplied or approved replacement parts.
  - Do not modify the machine from its original design.
  - Block machine tires before jacking machine up.
  - Jack machine up at designed locations only. Support machine with jack stands.
  - Use hoist or jack that will support the weight of the machine.
  - Do not push or tow the machine without an operator controlling the machine,
  - Do not push the machine on inclines with brake disabled.
  - Avoid moving parts. Do not wear loose clothing or jewelry and secure long hair.
  - Do not disconnect the off-board charger's DC cord from the machine's receptacle when the charger is operating. Arcing may result. If the charger must be interrupted during charging cycle, disconnect the AC power supply cord first.
  - Do not use incompatible battery chargers as this may damage battery packs and potentially cause a fire hazard.
  - Inspect charger cord regularly for damage.
- Do not plug in charger if prongs are wet.
  - Open recovery tank to vent batteries if temperature is above 80°F/27°C when charging batteries.
  - Keep work area well ventilated.
  - Avoid contact with battery acid.
  - Always follow site safety rules when disposing battery compartment liquid.
  - Follow site safety rules concerning battery removal.
  - Keep all metal objects off batteries.
  - Use a non-conductive battery removal device.
  - Do not power spray or hose off machine. Electrical malfunction may occur. Use damp cloth.
  - Use a hoist or adequate assistance when lifting batteries.
  - Battery installation must be done by trained personnel.
  - Only use distilled water when filling the automatic battery watering tank.
  - Wear personal protection equipment as needed and where recommended in this manual.



For Safety: wear protective gloves.



For Safety: wear eye protection.

6. When loading/unloading machine onto/off truck or trailer:
- Drain tanks before loading machine.
  - Use a ramp that can support the machine weight and operator.
  - Do not operate on a slippery ramp.
  - Use caution when operating on ramp.
  - The machine may only be operated on gradients up to 2%.
  - Lower the scrub head and squeegee before tying down machine.
  - Turn machine off and remove key.
  - Block machine wheels.
  - Use tie-down straps to secure machine.

**SAFETY LABELS**

The safety labels appear on the machine in the locations indicated. Replace labels if they are missing or become damaged or illegible.

**WARNING LABEL** - Located on recovery tank cover.

	<b>⚠ WARNING</b>	<b>⚠ AVERTISSEMENT</b>	<b>⚠ ADVERTENCIA</b>
	<p><b>TO REDUCE THE RISK OF FIRE, EXPLOSION, ELECTRICAL SHOCK, OR INJURY:</b></p> <ul style="list-style-type: none"> <li>• Read manual before operating machine.</li> <li>• Do not use or pick up flammable materials.</li> <li>• Do not use near flammable liquids, vapors or combustible dusts.</li> <li>• Batteries emit hydrogen gas. Explosion or fire can result. Keep sparks and open flame away when charging.</li> <li>• Disconnect battery cables and charger plug before servicing machine.</li> <li>• Do not charge batteries with damaged cord.</li> <li>• Do not use outdoors. Store indoors.</li> </ul>	<p><b>POUR RÉDUIRE LES RISQUES D'INCENDIE, L'EXPLOSION, DE CHOC ELECTRIQUE OU DE LESSURE:</b></p> <ul style="list-style-type: none"> <li>• Lisez le manuel avant d'utiliser la machine.</li> <li>• N'utilisez pas ou ne ramassez pas de matériaux inflammables.</li> <li>• N'utilisez pas près de liquides, vapeurs ou poussières inflammables.</li> <li>• Les batteries émettent de l'hydrogène gazeux. Risque d'incendie et d'explosion. Évitez toute étincelle et toute flamme nue lors de la charge des batteries.</li> <li>• Débranchez les câbles des batteries et le cordon du chargeur avant l'entretien de la machine.</li> <li>• Ne chargez pas les batteries avec un cordon endommagé.</li> <li>• N'utilisez pas à l'extérieur. Entrez-la à l'intérieur.</li> </ul>	<p><b>PARA REDUCIR EL RIESGO DE INCENDIO, EXPLOSION, CHOQUE ELECTRICO, O LESIONS:</b></p> <ul style="list-style-type: none"> <li>• Lea el manual antes de utilizar la máquina.</li> <li>• No utilice ni recoja materiales inflamables.</li> <li>• No utilice la máquina cerca de líquidos, polvos o vapores inflamables.</li> <li>• Las baterías emiten hidrógeno. Peligro de incendio o explosión. Mantenga la máquina alejada de chispas y llamas cuando se esté cargando.</li> <li>• Desconecte los cables de la batería antes de realizar el servicio a la máquina.</li> <li>• No cargue las baterías si el cable está dañado.</li> <li>• No utilice la máquina al aire libre. Guárdela en un lugar cerrado.</li> </ul>

1215281



**WARNING LABEL - Spinning brush. Keep hands away.**  
Located on scrub head.

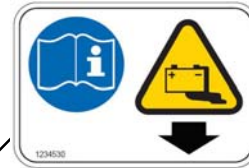
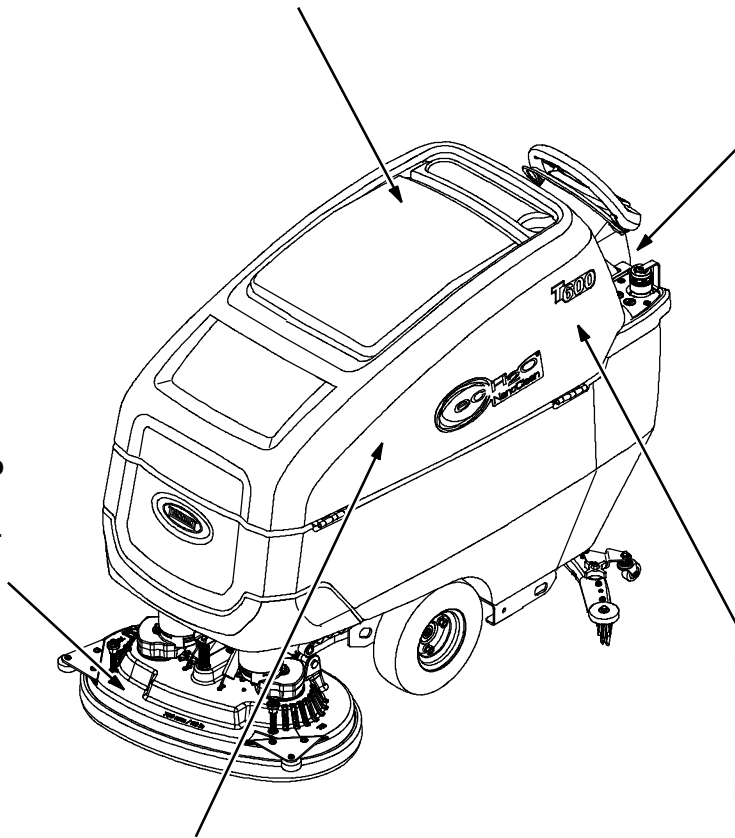

**FOR SAFETY LABEL - Read manual. Battery compartment drain hose. Avoid contact with battery acid.**  
Located above battery compartment drain hose.



**WARNING LABEL - Batteries emit hydrogen gas. Explosion or fire can result. Keep sparks and open flame away when charging.**  
Located on bottom side of recovery tank.



**WARNING LABEL - Electrical hazard. Disconnect battery cables before servicing machine.**  
Located above battery cable connectors.

# OPERATION

## MACHINE COMPONENTS

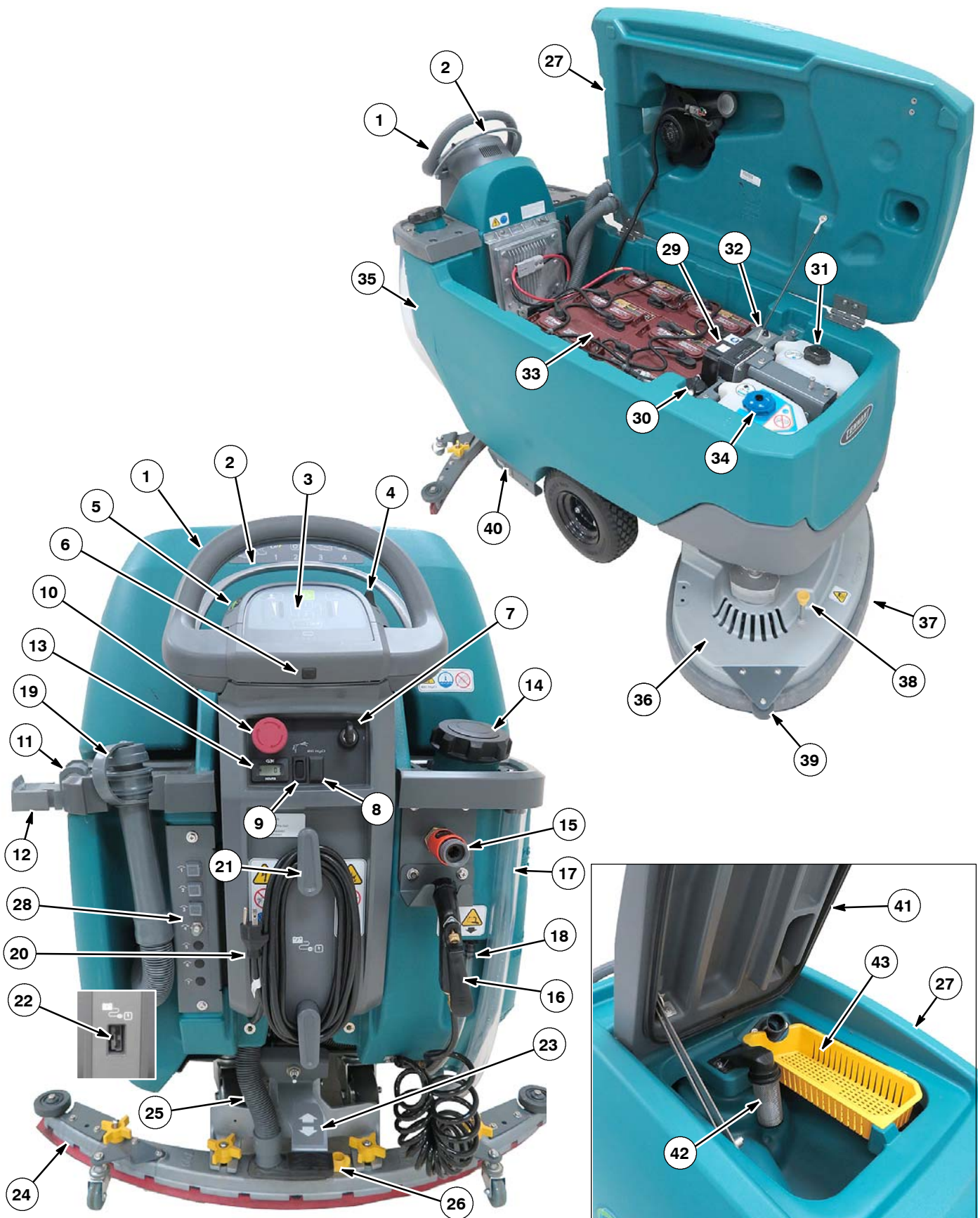



**MACHINE COMPONENTS**

- |  |   |
|--|---|
| <ol style="list-style-type: none"> <li>1. Control handle</li> <li>2. Variable speed control start bail</li> <li>3. Control panel</li> <li>4. Directional lever</li> <li>5. Speed control dial</li> <li>6. USB port (Service only)</li> <li>7. Key switch</li> <li>8. ec-H2O on/off switch (option)</li> <li>9. Spray nozzle on/off switch (T600 option)</li> <li>10. Emergency shut-off button</li> <li>11. Accessory rails</li> <li>12. Accessory rail clip (option)</li> <li>13. Hour meter</li> <li>14. Solution tank fill port</li> <li>15. Solution tank auto-fill hose port (option)</li> <li>16. Tank rinse out spray nozzle (T600 option)</li> <li>17. Solution tank level/drain hose</li> <li>18. Battery compartment drain hose</li> <li>19. Recovery tank drain hose</li> <li>20. On-board battery charger cord</li> <li>21. On-board battery charger cord hooks</li> <li>22. Off-board battery charger receptacle (off-board battery charger model)</li> </ol> | <ol style="list-style-type: none"> <li>23. Squeegee lower/lift foot pedal</li> <li>24. Squeegee assembly</li> <li>25. Squeegee vacuum hose</li> <li>26. Squeegee debris/drip tray</li> <li>27. Recovery tank</li> <li>28. Circuit breaker panel</li> <li>29. ec-H2O module (option)</li> <li>30. ec-H2O water conditioning cartridge</li> <li>31. Severe environment detergent tank (T600 ec-H2O option)</li> <li>32. Detergent mixing ratio knob (T600 Severe environment option)</li> <li>33. Battery compartment</li> <li>34. Automatic battery watering tank (option)</li> <li>35. Solution tank</li> <li>36. Scrub head</li> <li>37. Scrub head skirt</li> <li>38. Pad release plunger</li> <li>39. Wall rollers</li> <li>40. Transport tie-down bracket</li> <li>41. Recovery tank lid</li> <li>42. Recovery tank float shut-off screen</li> <li>43. Recovery tank debris tray</li> </ol> |
|--|---|

**SCRUB HEAD TYPES**

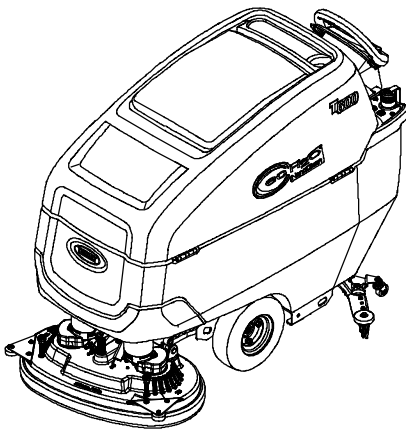

28 in / 700 mm Dual Disk  
 32 in / 800 mm Dual Disk  
 36 in / 900 mm Dual Disk

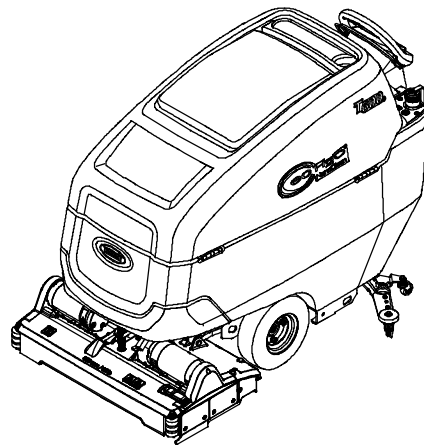

28 in / 700 mm Cylindrical Brush  
 32 in / 800 mm Cylindrical Brush

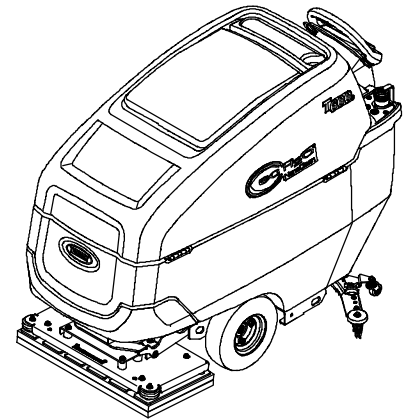

28 in / 700 mm Orbital Pad

# OPERATION

## CONTROL PANEL COMPONENTS

T600e CONTROL PANEL MODEL



1. 1-Step button
2. Brush pressure button
3. Brush pressure indicator
4. Solution flow button
5. Solution flow indicator
6. Service Indicator
7. Battery discharge indicator (BDI)
8. ec-H<sub>2</sub>O indicator (option)
9. Automatic battery watering indicator (option)

T600 PRO-MEMBRANE CONTROL PANEL MODEL

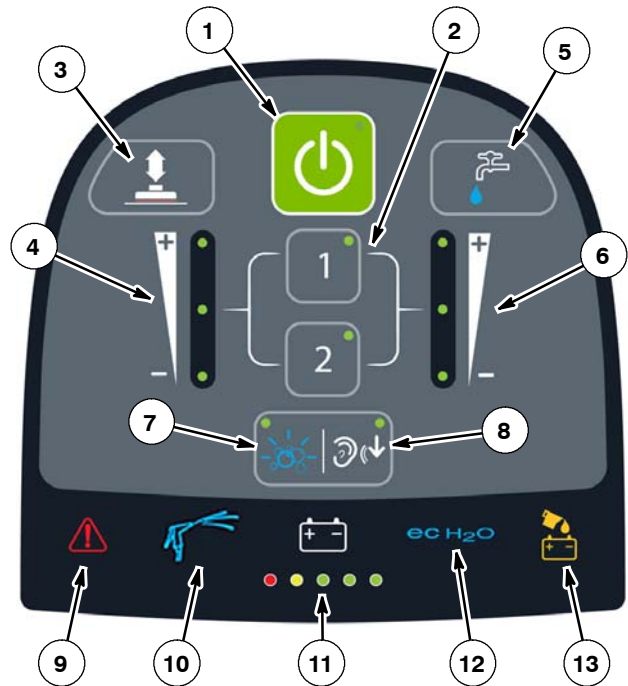

1. 1-Step button
2. Preset zone control buttons
3. Brush pressure button
4. Brush pressure indicator
5. Solution flow button
6. Solution flow indicator
7. Severe environment button (option)
8. Quiet-mode button
9. Service Indicator
10. Spray nozzle indicator (option)
11. Battery discharge indicator (BDI)
12. ec-H<sub>2</sub>O indicator (option)
13. Automatic battery watering indicator (option)

T600 PRO-PANEL CONTROLS MODEL

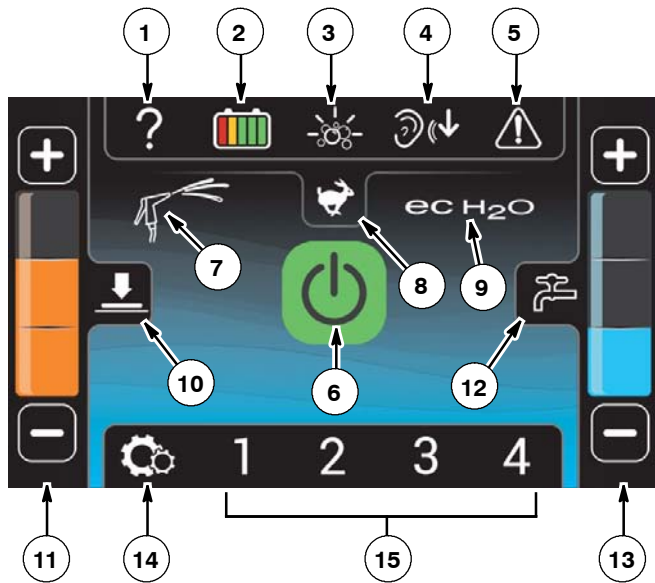

1. Help button
2. Battery discharge indicator (BDI)
3. Severe environment button
4. Quiet mode button
5. Service indicator button
6. 1-Step button
7. Spray nozzle indicator (option)
8. Maximum scrub speed button
9. ec-H2O indicator (option)
10. Brush pressure button
11. Brush pressure indicator
12. Solution flow button
13. Solution flow indicator
14. Machine Settings button
15. Preset zone control buttons

# OPERATION

## MACHINE SYMBOLS

	Read Manual		Automatic Battery Watering Tank (Option)
	Fast speed (drive model)		Detergent (ec-H2O Severe environment option)
	Slow speed (drive model)		No detergent (ec-H2O option)
	Forward / Reverse (drive model)		Water temperature (ec-H2O option)
	Key On		Circuit breaker
	Key Off		Do not power spray
	ec-H2O scrubbing (option)		
	Battery charge		
	Do not lift by accessory rails		
	No step		

## T600 PRO-PANEL SYMBOLS

	Home screen		Machine settings		Factory reset
	Back arrow		Operator videos		Operator
	Login		Supervisor menu		Supervisor
	Control help		Video Help		Add profile
	Start-up video		Add/Edit profiles		Edit profile
	About		Battery selection		Copy profile
	Video list button		Enable login		Delete profile
	Video button		Disable login		User login
	Video rotate view		Calibrate touch		Enter
					Backspace

## INSTALLING BATTERIES

**FOR SAFETY:** When servicing machine, battery installation must be done by trained personnel.

**⚠ WARNING:** Batteries emit hydrogen gas. Explosion or fire can result. Keep sparks and open flame away when charging.

**FOR SAFETY:** When servicing machine, wear appropriate personal protection equipment as needed. Avoid contact with battery acid.

### BATTERY SPECIFICATIONS

Requires six 6 volt deep-cycle batteries, ≤ 360 Ah @ 20 hr. Contact distributor or Tennant for battery recommendations.

**FOR SAFETY:** Before leaving or servicing machine, stop on level surface, turn off machine and remove key.

1. Lift the recovery tank to access the battery compartment (Figure 1).

**NOTE:** If there is liquid in battery compartment, drain battery compartment before installing batteries. See BATTERY COMPARTMENT DRAIN HOSE.



FIG. 1

2. Carefully install the batteries into the battery compartment tray and arrange the battery posts as shown (Figure 2). Insert foam spacers around batteries as shown.

**FOR SAFETY:** When servicing machine, use a hoist or adequate assistance when lifting batteries.

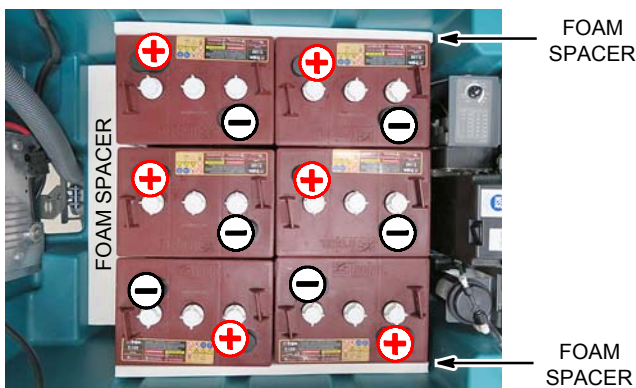

FIG. 2

3. Using the supplied battery post boots, connect the cables to battery posts, RED TO POSITIVE (+) & BLACK TO NEGATIVE (-) (Figure 3).

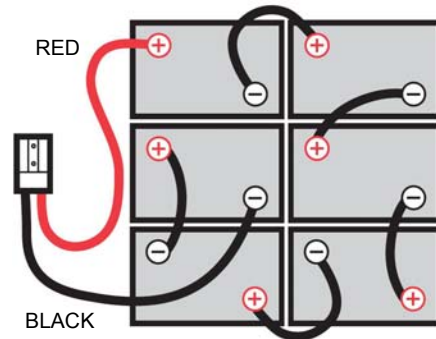

FIG. 3

**IMPORTANT:** Before charging batteries, make sure the battery charger and the machine's battery discharge indicator are properly set for battery type. Failure to properly set will result in battery damage. See BATTERY CHARGER SETTINGS.

**ATTENTION:** Do not disconnect battery cables while charger is plugged in, circuit board damage may result.

**IRIS® Battery Charging Metrics Notification:** Machines equipped with capability to report battery charging data via IRIS are supplied with a charger and set of batteries from the factory. When a battery reaches its end of life and must be replaced, Tennant highly recommends that the same battery type be used to continue to maximize the machines performance. In the event a battery with a different amp hour (AH), type (Flooded, AGM, Gel), or manufacturer is selected for replacement please contact Tennant technical service department for assistance in determining the feasibility of the replacement batteries and if so, selecting the correct charging profile. Availability of IRIS battery metric reporting is not guaranteed with third party supplied batteries.

## HOW THE MACHINE WORKS

### Conventional scrubbing:

When using the conventional scrubbing mode, water and detergent mixture from the solution tank flows to the floor and the rotating brush(es)/pad(s) scrub the floor clean. As the machine moves forward, the squeegee with vacuum suction picks up the dirty solution from the floor into the recovery tank.

### ec-H2O NanoClean Technology (option):

When using the ec-H2O NanoClean technology, normal water passes through a module where it is electrically converted into a cleaning solution. The electrically converted water attacks the dirt, allowing the machine to easily scrub away the suspended soil. The converted water then returns to normal water in the recovery tank.

# OPERATION

## BRUSH AND PAD INFORMATION

For best cleaning results use the appropriate brush or pad for your cleaning application. Listed below are brushes and pads and the applications for which each is best suited.

*NOTE: The amount and type of soilage play an important role in determining the type of brush or pad to use. Contact a Tennant representative for specific recommendations.*

**Soft nylon bristle scrub brush (White)** - Recommended for cleaning coated floors without removing finish. Cleans without scuffing.

**Polypropylene bristle scrub brush (Black)** - This general purpose polypropylene bristle scrub brush is used for scrubbing lightly compacted soilage. This brush works well for maintaining concrete, wood and grouted tile floors.

**Super abrasive bristle scrub brush (Gray)** - Nylon fiber impregnated with abrasive grit to remove stains and soilage. Strong action on any surface. Performs well on buildup, grease, or tire marks.

**Tufted pad driver** - Standard pad driver has short bristles, or “tufts,” on the back to hold the pad in place.

**Polishing pad (White)** - Used to maintain highly polished or burnished floors.

**Buffing pad (Red)** - Used for light duty scrubbing without removing floor finish.

**Scrubbing pad (Blue)** - Used for medium to heavy-duty scrubbing. Removes dirt, spills, and scuffs and leaves surface clean ready for re-coating.

**Stripping pad (Brown)** - Used for stripping of floor finish to prepare the floor for re-coating.

**Heavy duty stripping pad (Black)** - Used for aggressive stripping of heavy finishes/sealers, or very heavy duty scrubbing.

**Surface preparation pad (Maroon)** - Used for very aggressive chemical free removal of floor finish to prepare the floor for re-coating.

**Turf scrubbing pad (Green)** - Used to scrub uneven floor surfaces with crevices, cracks and deep grout lines.

**Melamine scrubbing pad (Orbital scrub head model)** - Made of an open-cell polymeric foam that removes black marks from floors and restores tile.

## MACHINE SETUP

### INSTALLING SQUEEGEE ASSEMBLY

Scrub heads and squeegee assemblies are identified by size (Figure 4). Refer to table below for appropriate squeegee assembly size for specific scrub head size.



FIG. 4

Scrub Head Size	Standard Squeegee Size	Narrow Aisle Squeegee Size
700 mm Disk	650 mm	n/a
800 mm Disk	700 mm	650 mm
900 mm Disk	800 mm	700 mm
700 mm Cylindrical	650 mm	n/a
800 mm Cylindrical	700 mm	650 mm
700 mm Orbital	650 mm	n/a

**FOR SAFETY: Before leaving or servicing machine, stop on level surface, turn off machine and remove key.**

1. Lift the squeegee mount bracket to the raised position. Place foot under pedal to lift (Figure 5).



FIG. 5

2. Mount the squeegee assembly to the squeegee mount bracket (Figure 6). Tighten knobs to secure squeegee assembly to bracket.

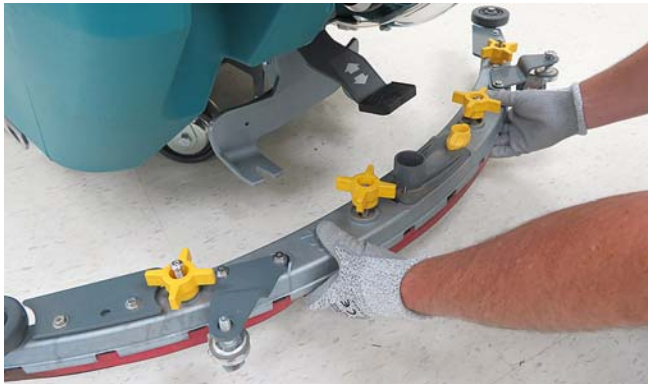

**FIG. 6**

3. Connect the vacuum hose to the squeegee assembly (Figure 7).

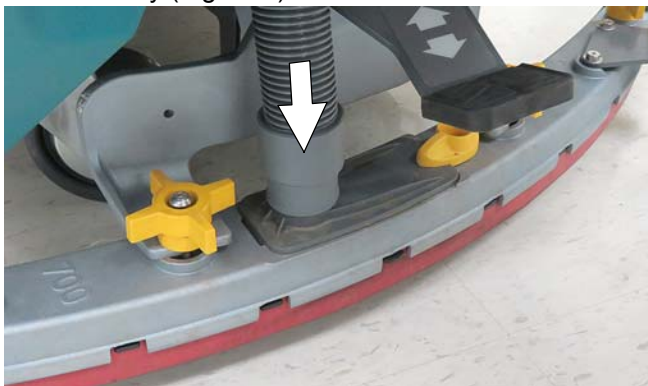

**FIG. 7**

4. Check squeegee blade for proper deflection. Lower squeegee to floor and propel machine forward for a short distance. The rear blade should deflect evenly across the full length of the squeegee as shown (Figure 8). Make sure the squeegee casters are in their normal position.

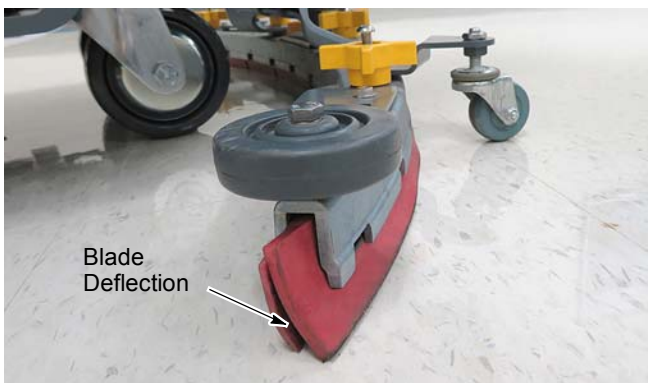

**FIG. 8**

5. To adjust for proper blade deflection, loosen the locking nut on caster and set the caster height to 3.25 in (82.7 mm) (Figure 9). Re-tighten locking nut and repeat step for other caster.

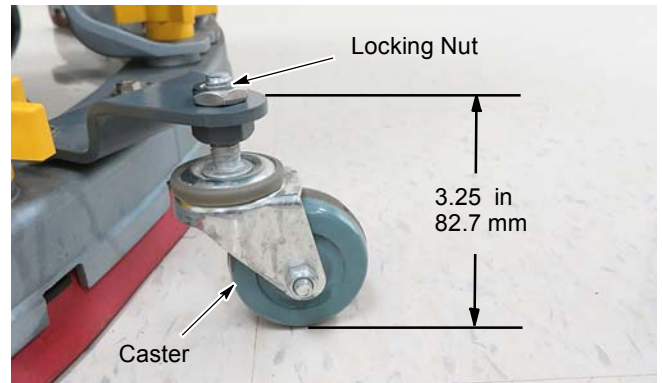

**FIG. 9**

6. If the squeegee blade does not deflect evenly across the full length of the squeegee after properly adjusting casters, the blade pitch may be out of adjustment (Figure 10).

*NOTE: The blade pitch adjustment is factory set and should not require further adjustment. However, if blade tips are higher or lower than center of squeegee, blade pitch adjustment is required.*

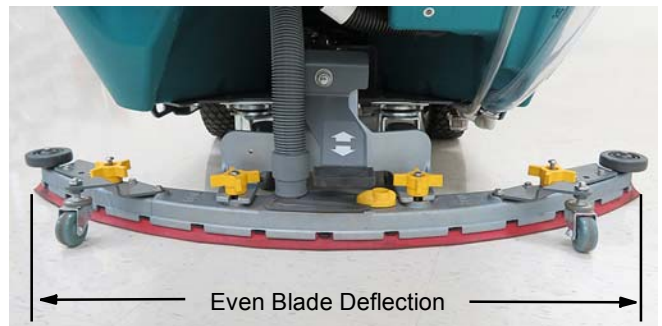

**FIG. 10**

7. To readjust blade pitch, loosen locking nut on adjustment shaft and rotate shaft counterclockwise to raise squeegee tips or clockwise to lower squeegee tips (Figure 11). 7mm and 17mm wrench required.



**FIG. 11**

# OPERATION

## INSTALLING AND REMOVING DISK BRUSHES/PADS (Disk Scrub Head Model)

1. Raise scrub head off floor and remove key.

**FOR SAFETY: Before leaving or servicing machine, stop on level surface, turn off machine and remove key.**

2. Attach the pad to the pad driver before installing the driver. Secure pad with center-lock (Figure 12).



FIG. 12

**FOR SAFETY: Do not operate machine with pads or accessories not supplied or approved by Tennant. The use of other pads may impair safety.**

3. Set the yellow spring clips to the open position to make brush installation easier. Press spring clips together then downward to set (Figure 13).

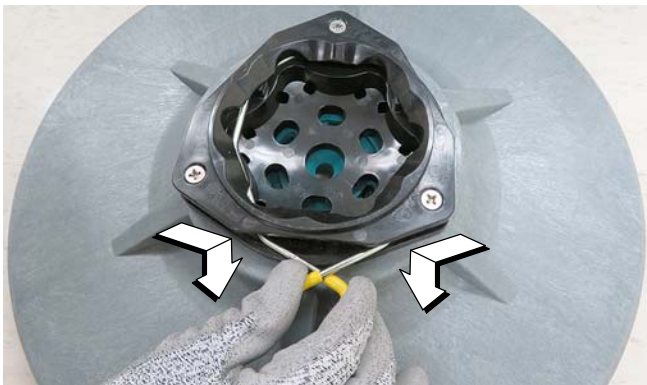

FIG. 13

4. Align the pad driver or brush under the motor hub and push it upward to engage hub (Figure 14).

Replace pads or brushes when they no longer clean effectively or when the bristles on the brush disk are worn to the yellow indicator (Figure 14).

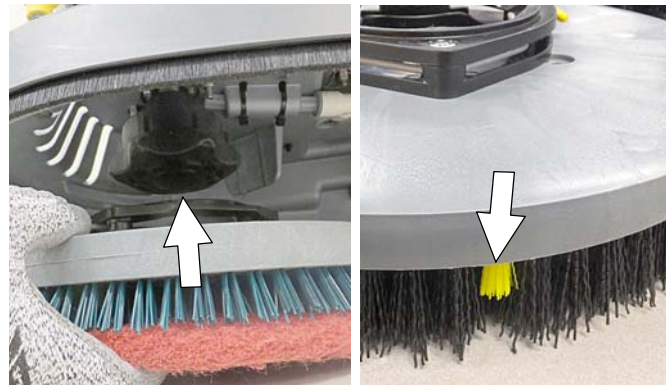

FIG. 14

5. To remove the pad drivers/brushes, raise the scrub head and press down on the yellow pad release plunger (Figure 15). Pad will drop to floor.

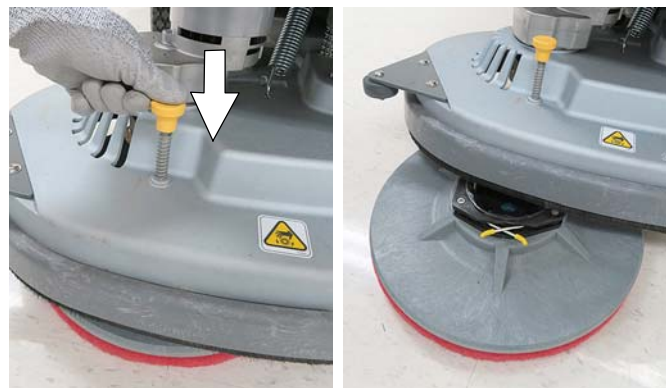

FIG. 15



**INSTALLING ORBITAL PADS**

(Orbital Scrub Head Model)

For best cleaning performance and to avoid damaging the pad driver plate or floor surface, always use backer pad with working pads (Figure 16).

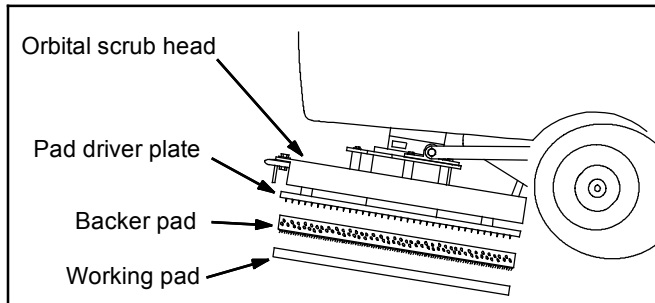

FIG. 16

1. Raise scrub head off floor and remove key.

**FOR SAFETY: Before leaving or servicing machine, stop on level surface, turn off machine and remove key.**

**FOR SAFETY: Do not operate machine with pads or accessories not supplied or approved by Tennant. The use of other pads may impair safety.**

2. Attach backer pad, retaining strips facing downward, to working pad (Figure 17).



FIG. 17

3. Attach the two pads to the bottom of the scrub head (Figure 18). Make sure pad is centered on scrub head.



FIG. 18

**INSTALLING CYLINDRICAL BRUSHES**

(Cylindrical Brush Scrub Head Model)

1. Raise scrub head off floor and remove key.

**FOR SAFETY: Before leaving or servicing machine, stop on level surface, turn off machine and remove key.**

2. Unfasten yellow latch and remove the idler plate from the scrub head (Figure 19).



FIG. 19

3. Attach idler plate to brush end with double row of bristles (Figure 20).

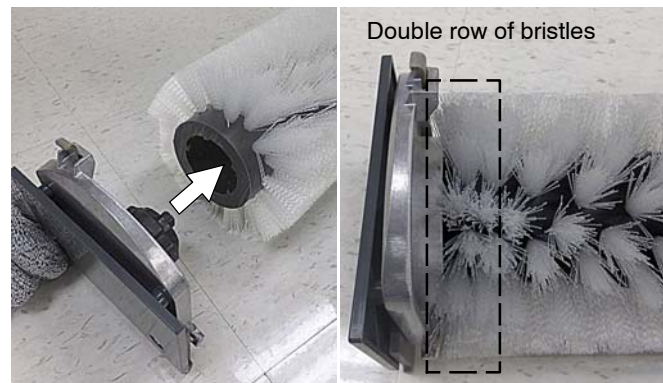

FIG. 20

4. Guide brush onto the drive hub and refasten latch (Figure 21).

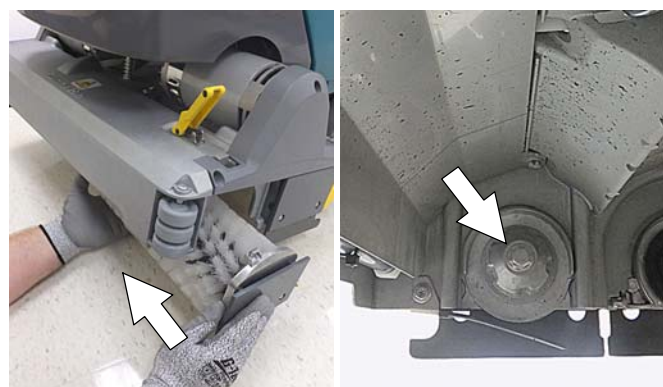

FIG. 21

# OPERATION

## FILLING SOLUTION TANK

**FOR SAFETY:** Before leaving or servicing machine, stop on level surface, turn off machine and remove key.

1. Remove the cap from the solution tank. Insert the fill hose into the yellow strainer. The ribs at bottom of strainer will hold hose in place while filling (Figure 22).

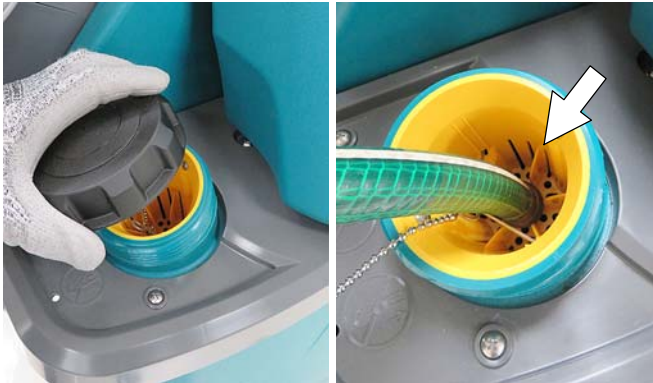

FIG. 22

2. Fill the solution tank with water until level reaches the "32 G/120 L" mark on the solution tank indicator (Figure 23).

**ec-H2O Scrubbing (Option)**- Fill solution tank with only cool clean water (less than 70°F/21°C). Do not add conventional floor cleaning detergents. An ec-H2O system fault will occur if cleaning detergents are added.

**Conventional Scrubbing** - Fill solution tank with water (not to exceed 140°F/60°C). Pour a recommended cleaning detergent into the solution tank according to mixing instructions on the container.



FIG. 23

**ATTENTION:** For Conventional Scrubbing, only use commercially approved cleaning detergents. Machine damage due to improper detergent usage will void the manufacturer's warranty.

**⚠ WARNING:** Flammable materials can cause an explosion or fire. Do not use flammable materials in tank(s).

*NOTE:* Do not use the ec-H2O system when there are conventional cleaning detergents in the solution tank. Drain, rinse, and refill the solution tank with clear cool water before operating the ec-H2O system. Conventional cleaning detergents will cause an ec-H2O system fault.

3. Turn off the water supply and remove the fill hose from yellow strainer.
4. Replace the cap on the solution tank.

## USING SOLUTION TANK AUTO-FILL (OPTION)

**FOR SAFETY:** Before leaving or servicing machine, stop on level surface, turn off machine and remove key.

1. Connect the quick-disconnect auto-fill coupler to the water supply hose and connect the nipple fitting to the machine (Figure 24).



FIG. 24

2. Press the quick-disconnect coupler into the nipple fitting unit it clicks (Figure 25). To prevent hose from being pulled out while tank is being filled, turn collar on coupler clockwise to lock connection.

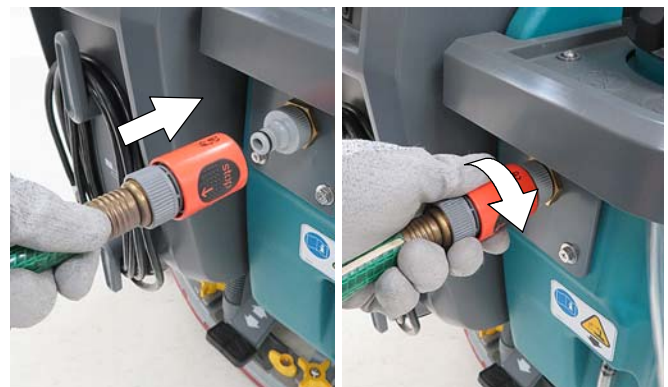

FIG. 25

- Before filling the solution tank with the auto-fill option make sure the solution tank cap is securely in place (Figure 26).



FIG. 26

- Turn the water supply on. The water flow will automatically stop when solution tank is full.

**FOR SAFETY: When operating machine, do not leave machine unattended when filling solution tank with auto-fill feature.**

- After solution tank is full, turn water supply off.
- Turn collar on coupler counter-clockwise to unlock connection. Then simply pull back on coupler to disconnect hose from machine (Figure 27).

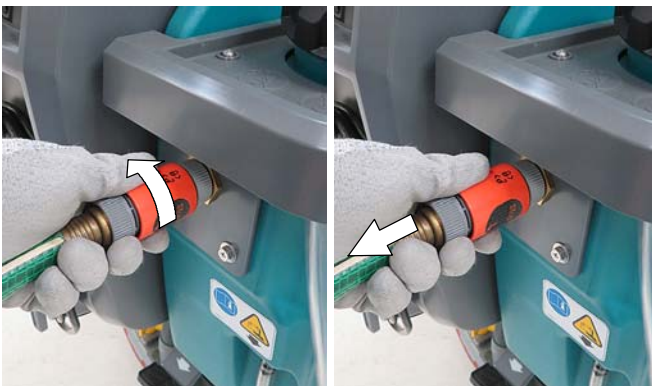

FIG. 27

- Remove the quick-disconnect auto-fill coupler from the water supply hose and store in a safe location.

### FILLING SEVERE ENVIRONMENT DETERGENT TANK (T600 ec-H2O MODEL OPTION)

**FOR SAFETY: Before leaving or servicing machine, stop on level surface, turn off machine and remove key.**

- Lift the recovery tank to access the severe environment detergent tank (Figure 28). Drain recovery tank before lifting tank.



FIG. 28

- Remove black cap from detergent tank and add a recommended cleaning detergent at full concentration (Figure 29). Do not add water. Use a funnel to prevent splashing liquid on scrub head motors below.



FIG. 29

**⚠ WARNING: Flammable materials can cause an explosion or fire. Do not use flammable materials in tank(s).**

**ATTENTION:** Only use commercially approved cleaning detergents in the severe environment tank. Do not use cleaners based with d-limonene. Machine damage due to improper detergent usage will void the manufacturer's warranty.

*NOTE: To prevent from running out of detergent while operating, it is recommended to refill the severe environment tank when refilling the solution tank.*

- Replace cap on detergent tank.

## OPERATION

- Adjust the detergent mixing ratio knob according to the cleaning detergent's mixing instructions (Figure 30).



FIG. 30

### ec-H2O WATER CONDITIONING CARTRIDGE (ec-H2O MODEL)

The ec-H2O system is equipped with a water conditioning cartridge (Figure 31). The cartridge is designed to protect the machine's plumbing system from potential scaling.

The cartridge is required to be replaced when it reaches its maximum water usage or expiration time on when the cartridge was activated, which ever comes first.

Depending on machine usage a new cartridge can last anywhere from 12 to 24 months.



FIG. 31

The control panel will signal the following code when it's time to replace the cartridge (Figure 32). The ec-H2O icon will begin to blink blue and red. See SERVICE INDICATOR CODES for further details.

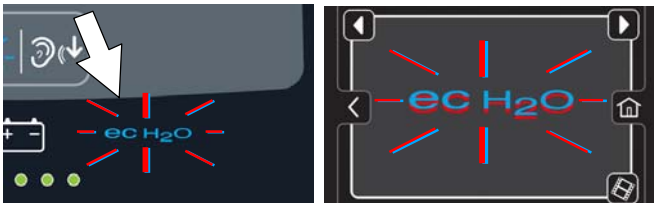

Pro-Membrane Model

Pro-Panel Model

FIG. 32

All cartridges are labeled with a manufacture date. The shelf-life of an un-installed cartridge is one year from manufacture date. For new cartridge replacement, the ec-H2O module timer must be reset. See ec-H2O WATER CONDITIONING CARTRIDGE REPLACEMENT.

**ATTENTION:** During first time use and after replacing the water conditioning cartridge, the ec-H2O system will automatically override the selected solution flow rate for up to 75 minutes.

### FILLING AUTOMATIC BATTERY WATERING TANK (OPTION)

**FOR SAFETY:** Before leaving or servicing machine, stop on level surface, turn off machine and remove key.

- Lift the recovery tank to access the automatic battery watering tank (Figure 33). Drain recovery tank before lifting tank.



FIG. 33

- Remove the blue cap from the automatic battery watering tank (Figure 34).
- Pour distilled water into tank (Figure 34). Use a funnel to prevent splashing liquid on scrub head motors below.

**FOR SAFETY:** When operating machine, only use distilled water when filling the automatic battery watering tank.



FIG. 34

- When the tank needs refilling, the automatic battery watering indicator will alert user to add distilled water (Figure 35). See CONTROL PANEL OPERATION for further details.

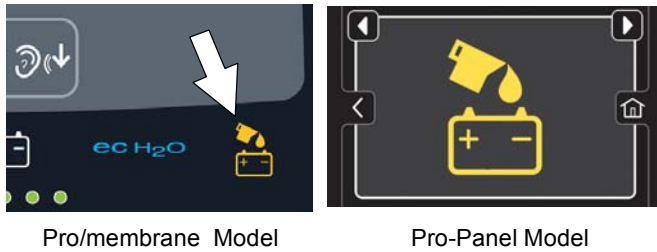

FIG. 35

### ACCESSORY RAILS

The machine is equipped with two accessory rails which straddle the control console. An optional accessory rail clip allows for storage of wet floor signs, spray bottles, debris bags and other items (Figure 36).



FIG. 36

To install the accessory rail clip, hook the clip over the rail and push downward until it snaps into position. To remove clip, reach under clip and carefully pull the latch tab downward to release from rail (Figure 37).

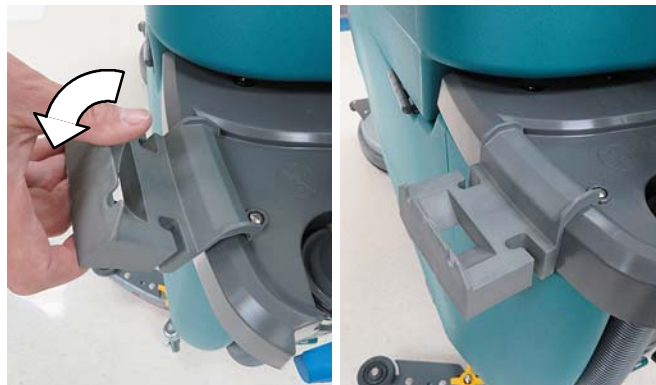

FIG. 37



**ATTENTION:** Do not use the accessory rails to lift machine, damage may occur.



**ATTENTION:** Do not step on accessory rails, damage may occur.

## CONTROL PANEL OPERATION

The control panel operation can be set up with lockout functionality by using the Supervisor Controls feature. This will prevent the operator from changing or saving the settings. See **SUPERVISOR CONTROLS** instructions at the back of the manual.

The supervisor controls feature will lower machine variability for consistent, repeatable cleaning results, provide machine quality assurance regardless of user experience, and reduce user training requirements.

### T600e CONTROL PANEL

#### 1-STEP BUTTON

With key turned on, press the 1-STEP button to activate the scrub function (Figure 38). The scrub head will lower to floor. Press button again to stop the scrub function and to raise scrub head.



FIG. 38

#### BRUSH PRESSURE BUTTON

Press the brush pressure button to increase or decrease the brush pressure (Figure 39). The brush pressure LED indicator will display the pressure setting.

##### Standard model:

One LED = Low pressure, two LEDs = High pressure.

**Heavy Duty down pressure model:** One LED = Low pressure, two LEDs = High pressure, Three LEDs = Heavy Duty pressure.

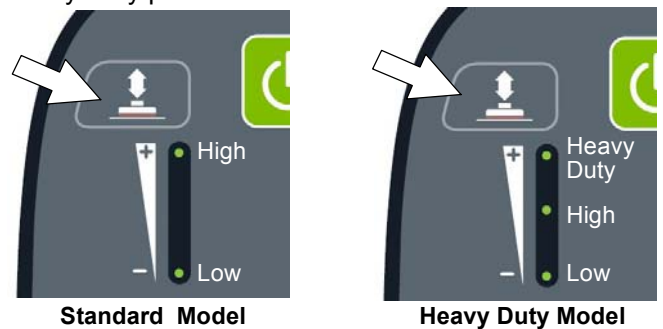

FIG. 39

# OPERATION

## SOLUTION FLOW BUTTON

Press the solution flow button to increase or decrease the solution flow rate (Figure 40). The solution flow indicator will display flow setting. No LED = No flow, One LED = Low flow, two LEDs = Medium flow, three LEDs = High flow.



FIG. 40

## ec-H2O INDICATOR (Option)

The ec-H2O system automatically turns on at each key start. A blue ec-H2O indicator will appear on the control panel indicating that the system is activated. To turn off the ec-H2O system, press the ec-H2O switch located below the key switch. The blue ec-H2O indicator will disappear (Figure 41).

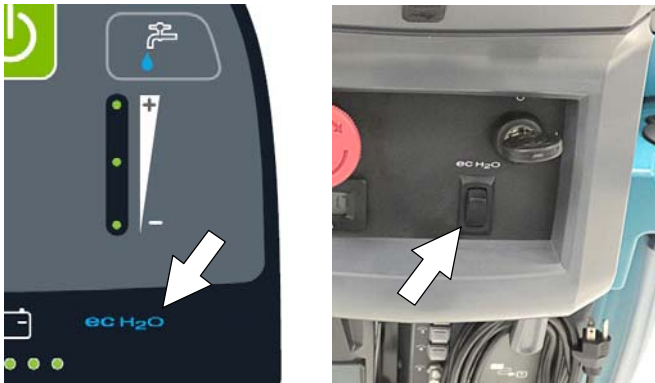

FIG. 41

**NOTE:** If a fault occurs to the ec-H2O system, the machine will automatically turn off the ec-H2O system and convert over to conventional scrubbing. The service indicator icon will remain solid red or continue to blink red until the ec-H2O fault is serviced.

ec-H2O INDICATOR	CONDITION
Solid blue	Normal operation
Blinking blue/red	Water conditioning cartridge expired. Replace cartridge.
Solid or blinking red	A system fault has occurred. See Service Indicator Codes.

## SERVICE INDICATOR

When the machine or on-board battery charger detects a fault, the service indicator will light up and begin flashing (Figure 42). The battery discharge indicator lights will also flash a fault code. See SERVICE INDICATOR CODES to diagnose machine fault.

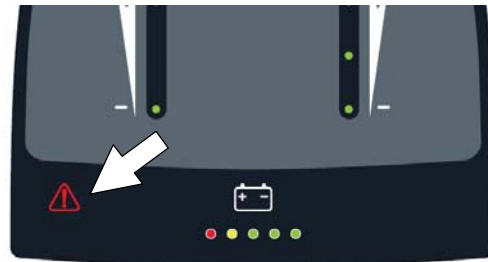

FIG. 42

## BATTERY DISCHARGE INDICATOR

The battery discharge indicator (BDI) displays the charge level of the batteries while the machine is operating. When the batteries are fully charged, all five indicators are lit (Figure 43). When the discharge level reaches the red light, stop scrubbing and recharge the batteries. When the red light begins to flash, the scrub function will be disabled to protect the batteries from total discharge. The machine will still propel when the red light is flashing. This will allow user to transport the machine to the charging station.

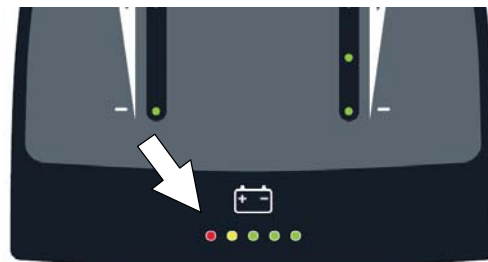

FIG. 43

**AUTOMATIC BATTERY WATERING INDICATOR (Option)**

The automatic battery watering (ABW) indicator will turn on and begin to flash when the battery watering tank is empty and needs refilling (Figure 44).

To protect the batteries from damage, the machine's scrub function will be disabled after 10 hours of continued use if tank is not refilled. When the indicator flashes rapidly, the scrub function will be disabled. Add distilled water and restart key to clear the flashing indicator. See FILLING AUTOMATIC BATTERY WATERING TANK.

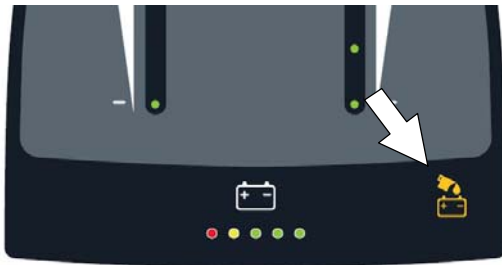

FIG. 44

ABW INDICATOR	CONDITION
Flashing	Empty ABW tank. Refill tank and restart key.
Solid	ABW system attempted to water batteries but batteries are already full or watering hose is kinked. Check for kink. Restart key.
Flashing rapidly	Empty ABW tank has been empty too long and scrub function has been disabled. Refill tank and restart key.

**T600 PRO-MEMBRANE CONTROL PANEL**

**1-STEP BUTTON**

With key turned on, press the 1-STEP button to activate the scrub function (Figure 45). The scrub head will lower to floor. Press button again to stop the scrub function and to raise scrub head.



FIG. 45

**BRUSH PRESSURE BUTTON**

Press the brush pressure button to increase or decrease the brush pressure (Figure 46). The brush pressure LED indicator will display the pressure setting.

**Standard model:** One LED = Low pressure, two LEDs = Medium pressure, three LEDs = High pressure.



**Heavy Duty down pressure model:**

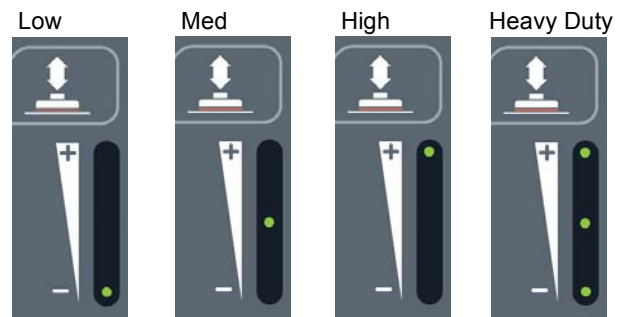

FIG. 46

**NOTE:** If brush pressure is set too high for scrubbing conditions, the brush pressure setting will automatically reduce to a lower setting and begin flashing. The flashing LED alerts the operator to reduce the brush pressure setting to prevent brush motor overload.

## OPERATION

### SOLUTION FLOW BUTTON

Press the solution flow button to increase or decrease the solution flow rate (Figure 47). The solution flow indicator will display flow setting. No LED = No flow, One LED = Low flow, two LEDs = Medium flow, three LEDs = High flow.



FIG. 47

### SEVERE ENVIRONMENT BUTTON (ec-H2O Model Option)

Press the Severe Environment button to deliver a boost of cleaning detergent for areas with excessive soil buildup (Figure 48).

Press button one time for a 30 second boost. A green LED in the corner will blink slowly when dispensing. During the last 5 seconds, the LED will blink rapidly as an alert that the dispensing is about to stop.

To deliver a continuous detergent boost, press and hold button for 2 seconds until green LED turns solid green. Press button at anytime to turn off.

To alert user when detergent tank is empty, the bubbles icon will blink for 15 seconds. If button is pressed when tank is empty, the bubbles icon will continue to blink for 15 seconds until tank is refilled.

*NOTE: When the severe environment mode is turned on, the ec-H2O system will automatically turn off and the brush pressure and solution flow settings will increase to the high settings. When turned off, the settings will revert back to the original settings. When operating the Severe Environment mode for extended periods, if desired, the solution flow rate and the down pressure can be decreased to a lower setting to conserve solution and detergent usage and optimize battery run time.*

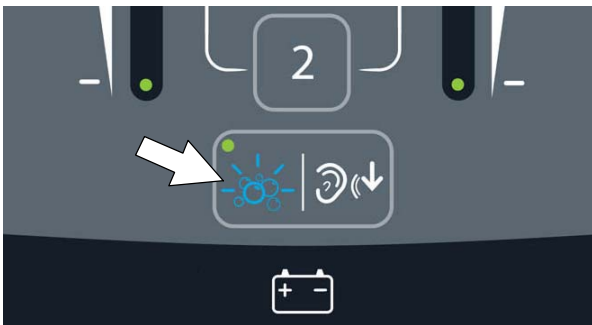

FIG. 48

### QUIET-MODE BUTTON

Press the Quiet-Mode button to reduce the vacuum motor sound. A green LED in the corner will turn on when activated. Press button to turn off.

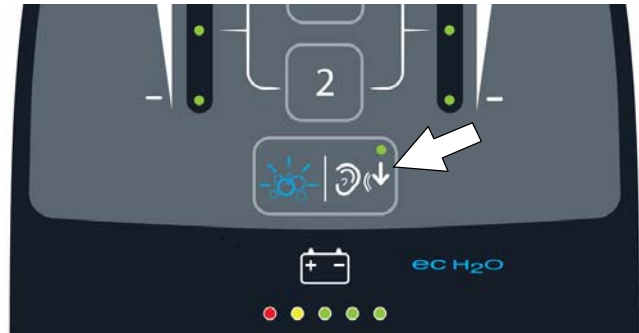

FIG. 49

### PRESET ZONE CONTROL BUTTONS

Use the zone control buttons to preset up to three zones with different solution flow rates, brush pressures, scrub speeds and scrub modes (Figure 50).

Zone 1 = Preset Zone Control Button 1

Zone 2 = Preset Zone Control Button 2

Zone 3 = Preset Zone Control Buttons 1 & 2

The zone control buttons are factory preset for different scrubbing applications. A green LED in the corner will turn on when activated. To use Zone 3, press zone buttons 1 & 2 at the same time.

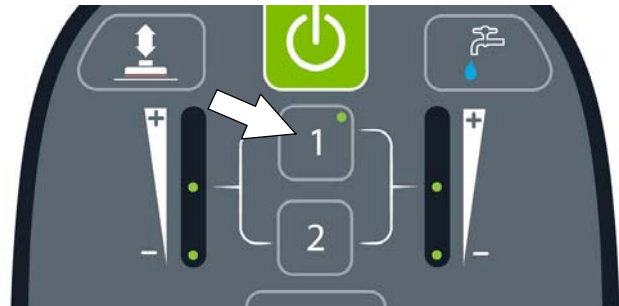

FIG. 50

To preset the zone control buttons for different scrubbing applications, select the desired settings from list below, then press and hold the zone button until the green LED blinks three times to save preset. To preset zone 3, press and hold zone buttons 1 & 2 at the same time.

- Brush pressure setting
- Solution flow rate
- Quiet-Mode on or off
- ec-H2O system on or off (option)
- Severe Environment mode on or off (T600 option)
- Maximum scrub speed (See Supervisor Controls)

*NOTE: The severe environment mode and ec-H2O system cannot be preset together.*



**ec-H<sub>2</sub>O INDICATOR (Option)**

The ec-H<sub>2</sub>O system automatically turns on at each key start. A blue ec-H<sub>2</sub>O indicator will appear on the control panel indicating that the system is activated. To turn off the ec-H<sub>2</sub>O system, press the ec-H<sub>2</sub>O switch located below the key switch. The blue ec-H<sub>2</sub>O indicator will disappear (Figure 51).

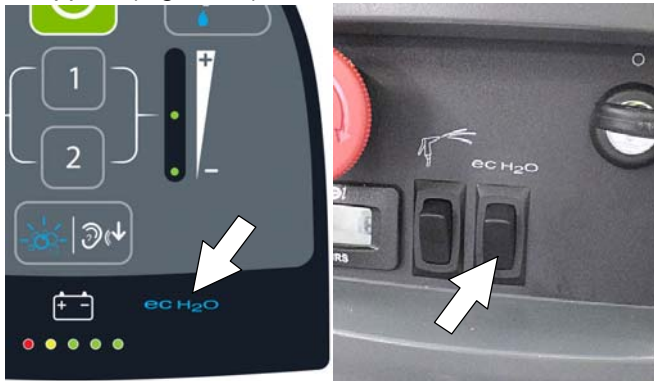

FIG. 51

**NOTE:** If a fault occurs to the ec-H<sub>2</sub>O system, the machine may automatically turn off the ec-H<sub>2</sub>O system and convert over to conventional scrubbing. The service indicator icon will remain solid red or continue to blink red until the ec-H<sub>2</sub>O fault is serviced.

ec-H <sub>2</sub> O INDICATOR	CONDITION
Solid blue	Normal operation
Blinking blue/red	Water conditioning cartridge expired. Replace cartridge.
Solid or blinking red	A system fault has occurred. See Service Indicator Codes.

**SERVICE INDICATOR**

When the machine or on-board battery charger detects a fault, the service indicator will light up and begin flashing (Figure 52). The battery discharge indicator lights will also flash a fault code. See SERVICE INDICATOR CODES to diagnose machine fault.

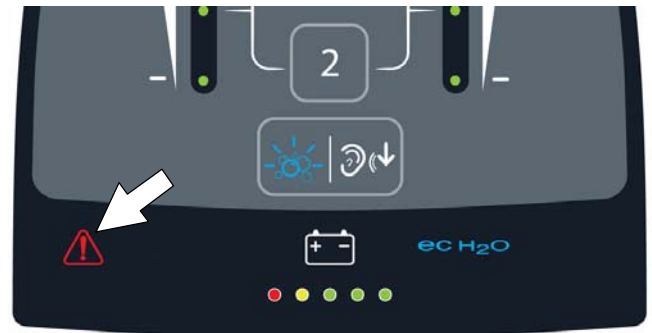

FIG. 52

**BATTERY DISCHARGE INDICATOR**

The battery discharge indicator (BDI) displays the charge level of the batteries while the machine is operating. When the batteries are fully charged, all five indicators are lit (Figure 53). When the discharge level reaches the red light, stop scrubbing and recharge the batteries. When the red light begins to flash, the scrub function will be disabled to protect the batteries from total discharge. The machine will still propel when the red light is flashing. This will allow user to transport the machine to the charging station.

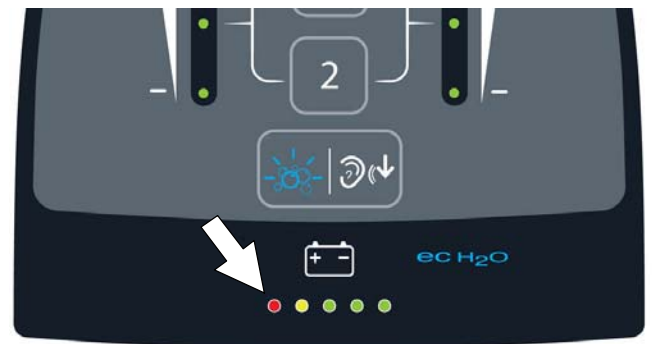

FIG. 53

# OPERATION

## AUTOMATIC BATTERY WATERING INDICATOR (Option)

The automatic battery watering (ABW) indicator will flash when the battery watering tank is empty and needs refilling (Figure 54).

To protect the batteries from damage, the machine's scrub function will be disabled after 10 hours of continued use if tank is not refilled. When the indicator flashes rapidly, the scrub function will be disabled. Add distilled water and restart key to clear the flashing indicator. See FILLING AUTOMATIC BATTERY WATERING TANK.

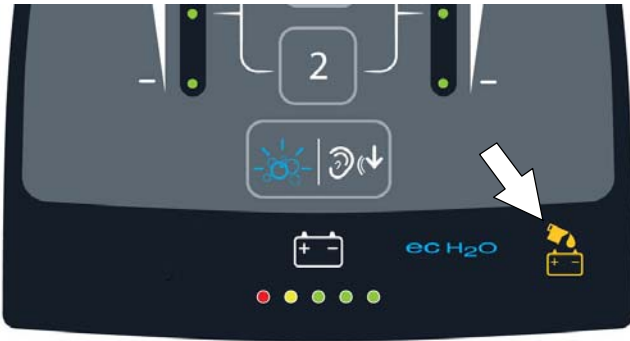

FIG. 54

## SPRAY NOZZLE INDICATOR (T600 Option)

The spray nozzle indicator will display when the spray nozzle switch is pressed (Figure 55). The switch activates the spray nozzle pump and disables the machine's propel when in use. If the start bail is pulled, the spray nozzle indicator will flash indicating that the spray nozzle pump is turned on. Press switch again to turn off spray nozzle pump. See OPERATING SPRAY NOZZLE.

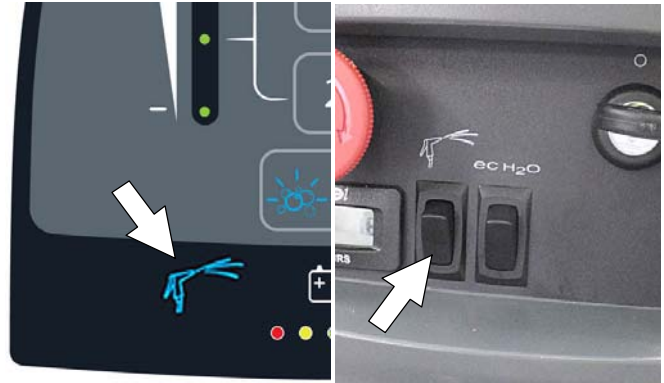

FIG. 55

ABW INDICATOR	CONDITION
Flashing	Empty ABW tank. Refill tank and restart key.
Solid	ABW system attempted to water batteries but batteries are already full or watering hose is kinked. Check for kink. Restart key.
Flashing rapidly	Empty ABW tank has been empty too long and scrub function has been disabled. Refill tank and restart key.

## T600 PRO-PANEL CONTROLS

### HOME SCREEN

There are two types of user modes that will interface with the home screen.

At key start up, a new machine from the factory will automatically start up in the supervisor mode.

**Supervisor Mode** - Capable of machine operation with full use of all controls, along with configuring permissions and restrictions for the operator mode and login capability.

**Operator Mode** - Capable of machine operation with permissions and restrictions controlled by the supervisor.

To configure the home screen with permissions and restrictions and login capability for Operator Mode, see SUPERVISOR CONTROLS instructions at the back of the manual.

**Supervisor Mode home screen** provides access to the machine settings button and to the maximum scrub speed button (Figure 56).



FIG. 56

**Operator Mode home screen** restricts access to the machine settings button and maximum scrub speed button (Figure 57).

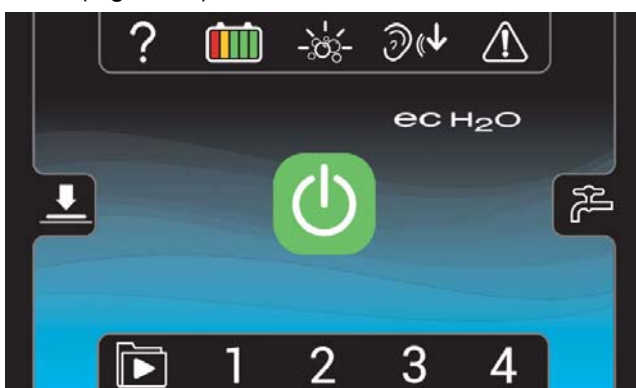

FIG. 57

### HELP BUTTON

For first time users, press the help button (?) to access the help screen. The help screen will allow you to select a different screen language, enable login settings, help identify control panel icons, view machine start-up video and access machine system information (Figure 58).

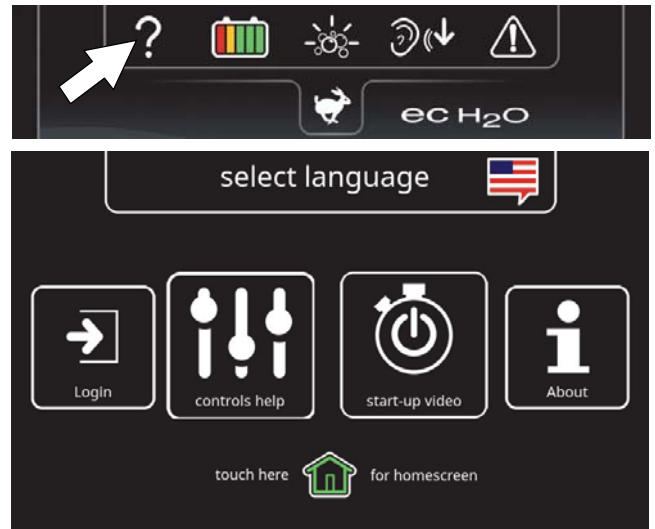

FIG. 58

### LOGIN SCREEN

When login is enabled in the supervisor mode, a login screen will appear at key start up (Figure 59 ). Enter your assigned login code and press the green arrow to access the home screen. See SUPERVISOR CONTROLS instructions at the back of the manual to enable login at start up.

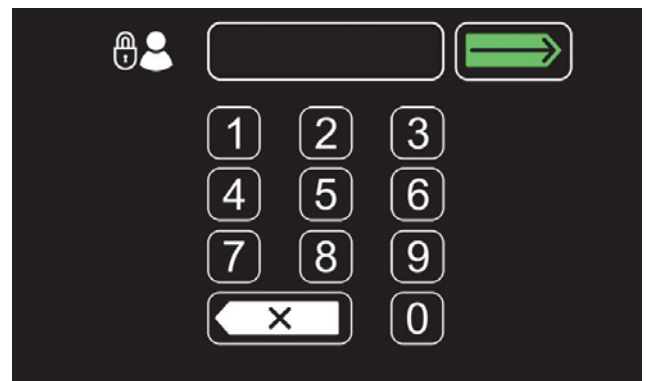

FIG. 59

# OPERATION

## ec-H2O INDICATOR (Option)

The ec-H2O system automatically turns on at each key start. The ec-H2O icon will appear on the home screen indicating that the system is activated (Figure 60). To turn off the ec-H2O system, press the ec-H2O switch located below the key switch. A slash mark over the icon will indicate that the ec-H2O system is turned off.

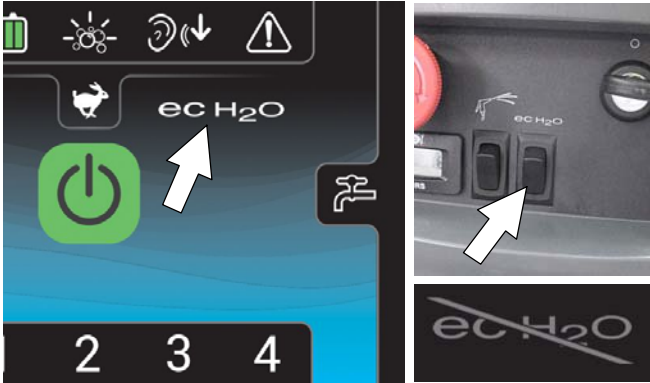

FIG. 60

## 1-STEP BUTTON

Press the 1-STEP button to activate the scrub function (Figure 61). The scrub head will lower to floor. Press button again to stop the scrub function and to raise scrub head.



FIG. 61

## BRUSH PRESSURE BUTTON

Press the brush pressure button to display the brush pressure indicator (Figure 62). Press the (+) button to increase brush pressure. Press the (-) button to decrease the brush pressure.



Standard model: Heavy Duty down pressure model:

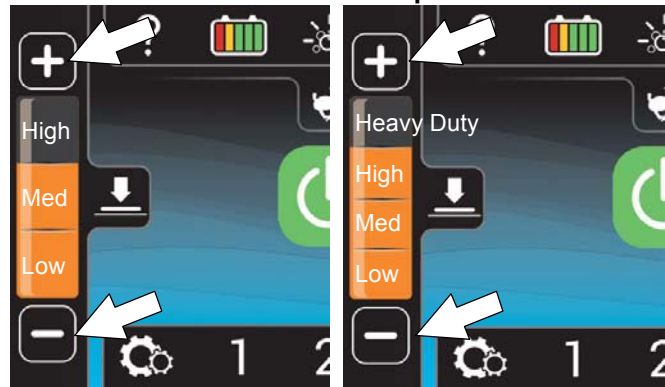

FIG. 62

**NOTE:** If brush pressure is set too high for scrubbing conditions, the brush pressure setting will automatically reduce to a lower setting and begin flashing. When flashing, reduce brush pressure to prevent brush motor overload.

## SOLUTION FLOW BUTTON

Press the solution flow button to display the solution flow indicator (Figure 63). Press the (+) button to increase solution flow. Press the (-) button to decrease the flow solution or to turn it off.

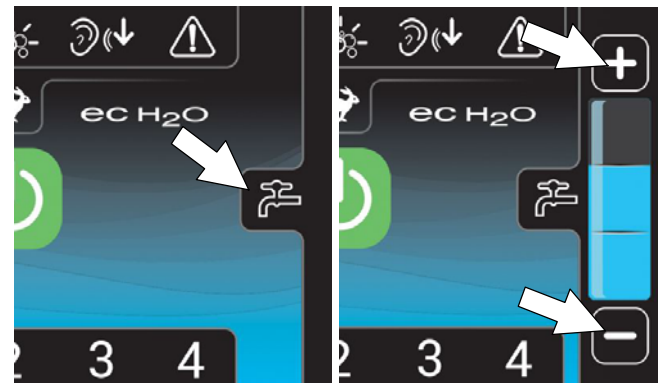

FIG. 63

**SEVERE ENVIRONMENT BUTTON  
(ec-H2O Model Option)**

Press the Severe Environment button to deliver a boost of cleaning detergent for areas with excessive soil buildup (Figure 64).

Press button one time for a 30 second detergent boost. The button will turn green and a 30 second count down timer will start. Press button at anytime to turn off.

To deliver a continuous detergent boost, press and hold button for 2 seconds until a continuous timer is displayed. Press button at anytime to turn off.

To alert user when the severe environment detergent tank is empty, the button will blink yellow.

*NOTE: When the severe environment mode is turned on, the ec-H2O system will automatically turn off and the brush pressure and solution flow settings will increase to the high settings. When turned off, the settings will revert back to the original settings. When operating the Severe Environment mode for extended periods, if desired, the solution flow rate and the down pressure can be decreased to a lower setting to conserve solution and detergent usage and optimize battery run time.*

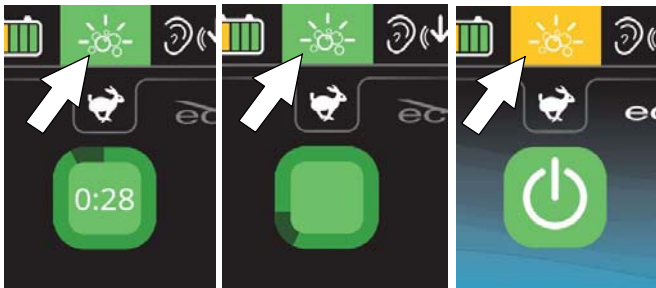

FIG. 64

**MAXIMUM SCRUB SPEED BUTTON**

Press the maximum scrub speed button to access the maximum speed scrub settings (Figure 65). Press the (+) button to increase the maximum scrub speed. Press the (-) button to decrease the maximum scrub speed. The maximum scrub speed button is only accessible in the Supervisor Mode. See *SUPERVISOR CONTROLS* instructions at the back of the manual for further details.

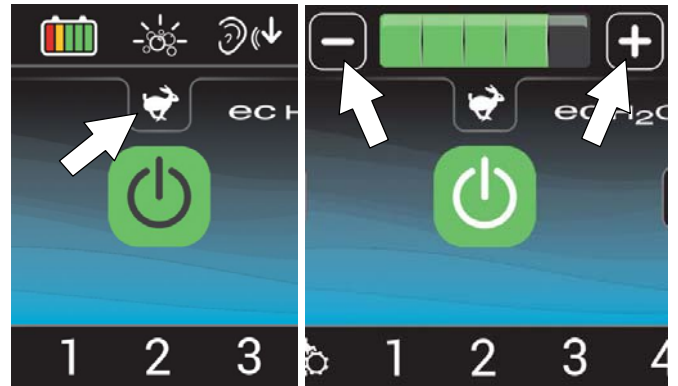

FIG. 65

**QUIET-MODE BUTTON**

Press the Quiet-Mode button to reduce the vacuum motor sound for noise restricted areas (Figure 66). The button will turn green when activated. Press button again to turn off.

*NOTE: When the Quiet-Mode is activated the water pickup will slightly be reduced.*



FIG. 66

## OPERATION

### SPRAY NOZZLE INDICATOR (T600 Option)

The spray nozzle indicator will display when the spray nozzle switch is pressed (Figure 67). The switch activates the spray nozzle pump and disables the machine's propel when in use. If the start bail is pulled, the spray nozzle indicator will flash indicating that the spray nozzle pump is turned on. To turn off spray nozzle, press the spray nozzle indicator or press switch again. See *OPERATING SPRAY NOZZLE*.

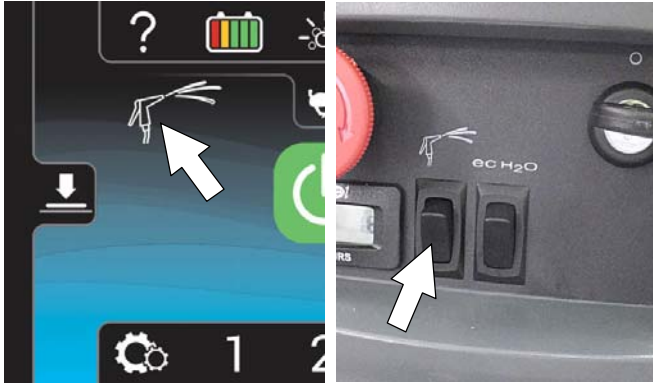

FIG. 67

### BATTERY DISCHARGE INDICATOR

The battery discharge indicator (BDI) displays the charge level of the batteries while the machine is operating. When the batteries are fully charged, all five indicators are lit (Figure 68). When the discharge level reaches the red light, stop scrubbing and recharge the batteries. When the red light begins to flash, the scrub function will be disabled to protect the batteries from total discharge. The machine will still propel when the red light is flashing. This will allow user to transport the machine to the charging station.



FIG. 68

### VIDEO TUTORIAL BUTTON (Operator Mode Home Screen)

Press the video tutorial button to access the video tutorial screen (Figure 69). It includes videos on how to perform specific operation and maintenance procedures. Press the video buttons to start video. Press the rotate button for additional videos. The lower right video button provides a list of additional tutorial videos.



FIG. 69

**PRESET ZONE CONTROL BUTTONS**

Use the zone control buttons to preset up to four zones with different solution flow rates, brush pressure, scrub speeds and scrub modes (Figure 70).

The four zone control buttons are factory preset for different scrubbing applications. The zone control button will turn green when zone is activated.

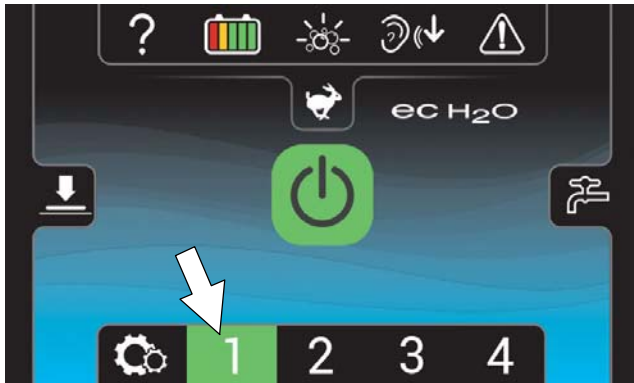

FIG. 70

To preset the zone control buttons for different scrubbing applications:

*NOTE: Only the supervisor mode has the capability to change the factory zone settings (See SUPERVISOR CONTROLS instructions at back of manual).*

1. Select the desired settings from list below,
  - Brush pressure rate
  - Solution flow rate
  - Quiet-Mode on or off
  - ec-H2O system on or off (option)
  - Severe Environment mode on or off (option)
  - Maximum scrub speed

*NOTE: The severe environment mode and ec-H2O system cannot be preset together.*

2. Then press and hold a zone button until a screen prompts you to name the new preset zone. Select “yes” to name the preset zone (Figure 71).

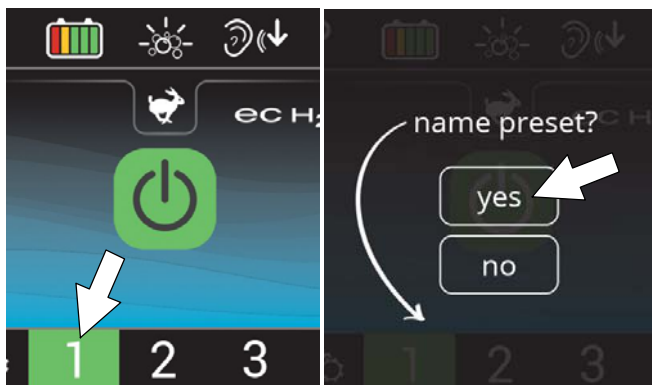

FIG. 71

3. If the zone settings are configured to scrub a lobby for example, name the zone “LOBBY” (Figure 72). Press the green arrow to save the new zone preset.



FIG. 72

4. The name will appear above the zone setting number when the zone button is pressed (Figure 73). Repeat process for other zone presets.



FIG. 73

**SERVICE INDICATOR BUTTON**

The service indicator button will flash yellow or red when a machine fault is detected (Figure 74). Press the service indicator button to view fault screen.

Flashing yellow indicates a warning that requires service, but machine is still operable. Flashing red indicates a fault which will shut down the machine and require service. See FAULT SCREENS below.



FIG. 74

# OPERATION

## FAULT SCREENS

When a fault is initially detected, the following fault screens will automatically pop up to indicate the fault.

Press the left and right arrow button at top of screen to scroll through the fault screens.

**Yellow machine fault Screen** (Figure 75) - Machine fault has been detected. A fault code will appear below the fault icon. See SERVICE INDICATOR CODES.



FIG. 75

**Flashing Blue and Red ec-H2O Screen** (Figure 76) - The water conditioning cartridge has expired. See ec-H2O WATER CONDITIONING CARTRIDGE REPLACEMENT.

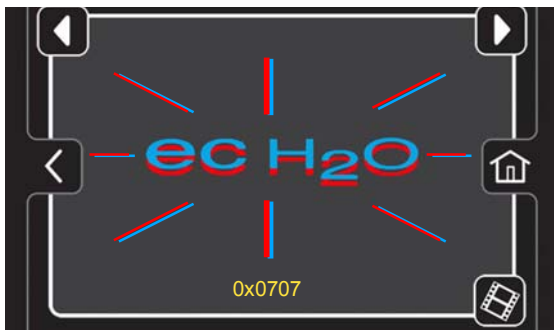

FIG. 76

**Yellow ec-H2O Fault Screen** - Machine detected an ec-H2O system water or plumbing fault (Figure 77).

**Red ec-H2O Fault Screen** - Machine detected an ec-H2O system electrical fault (Figure 77).

A fault code will appear below the ecH2O icon. See SERVICE INDICATOR CODES.

**NOTE:** If a fault occurs to the ec-H2O system, the machine may automatically turn off the ec-H2O system and convert over to conventional scrubbing. The service indicator button will continue to flash until the ec-H2O fault is serviced.

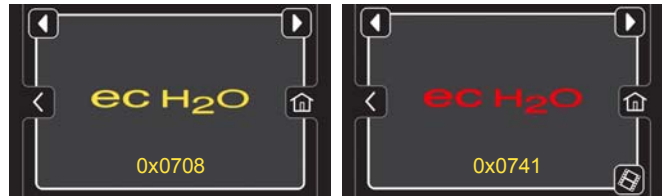

FIG. 77

**Yellow Automatic Battery Watering Fault Screen** - Code 0x0B06 - The Automatic Battery Watering tank is empty and needs refilling (Figure 78). To protect the batteries from damage, the machine's scrub function will be disabled after 10 hours of continued use if tank is not refilled. Add distilled water to the battery watering tank and restart key to clear fault. See FILLING AUTOMATIC BATTERY WATERING TANK.

Code 0x0B05 - ABW system attempted to water batteries but batteries are already full or watering hose is kinked. Check for kink. Restart key to clear fault.

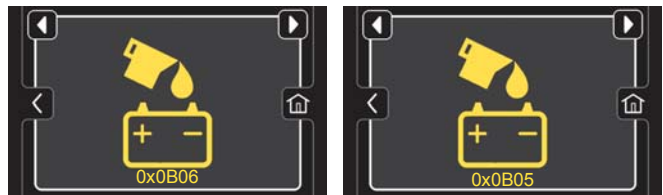

FIG. 78

**Red Automatic Battery Watering Fault Screen** - The Code 0x0B07 - Automatic Battery Watering tank is empty and needs refilling. The scrub function is disabled until tank is refilled (Figure 79). Add distilled water to the battery watering tank and restart key to clear fault. See FILLING AUTOMATIC BATTERY WATERING TANK.



FIG. 79



## MACHINE SETTINGS BUTTON

Press the machine settings button to access the following menu options (Figure 80).

The home screen must be in the supervisor mode to access the machine settings button. See SUPERVISOR CONTROLS instructions at back of manual for further details.

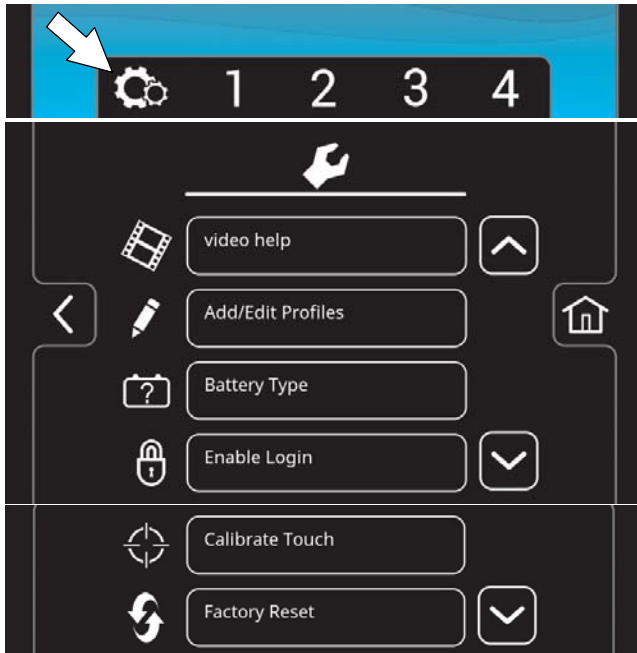

FIG. 80



**Video help** - Use to view specific operation and maintenance procedures. See Figure 69.



**Add/Edit Profiles** - Use to add/edit user profiles for machine use. See SUPERVISOR CONTROLS.



**Battery Type** - Use to configure the machine for different battery types. This ensures the on-board battery charger charging profile is properly programmed to your battery type. See BATTERIES.



**Enable Login** - Use to activate a required login code at machine start up to operate machine.



**Calibrate Touch** - Use this to recalibrate the touch screen if the touch points become misaligned.



**Factory Reset** - Resets the supervisor login code back to the factory default code, removes user profiles and resets any custom preset zone control buttons back to the factory preset zones. See SUPERVISOR CONTROLS.

# OPERATION

## MACHINE OPERATION

**FOR SAFETY: Do not operate machine unless operator manual is read and understood.**

### PRE-OPERATION CHECK LIST

- Sweep area and remove any obstructions.
- Check the battery fluid. Fill as necessary.
- Machines with Smart-Fill Automatic Battery Watering option: Check the automatic battery watering tank. Fill with distilled water as necessary.
- Check the battery charge level. Charge as necessary.
- Check brushes/pads for wear and damage.
- Check scrub head skirt for wear and damage.
- Check squeegee blades for wear, damage and for proper deflection adjustment.
- Clean the squeegee drip trap reservoir.
- Check the squeegee vacuum hose for debris or blockage.
- Confirm recovery tank is empty and clean.
- Confirm recovery tank debris tray is clean.
- Confirm recovery tank float shut-off screen is clean
- Cylindrical brush model - confirm debris trough is empty and clean.
- ec-H2O Scrubbing: Confirm solution tank is filled with clear cool water only.
- ec-H2O Scrubbing: Confirm all conventional cleaning agents/restorers are drained and rinsed from solution tank.
- Check machine for proper operation.

### OPERATING MACHINE

For control panel operating instructions, see CONTROL PANEL OPERATION.

1. Turn the key to the on ( I ) position (Figure 81).



FIG. 81

2. ec-H2O models - The ec-H2O system will automatically turn on at key start up. The ec-H2O indicator will appear on the control panel indicating that the system is activated (Figure 82).

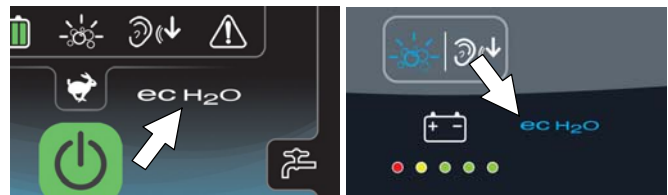

FIG. 82

**ATTENTION:** When conventional scrubbing with cleaning detergents in solution tank, make sure to turn off the ec-H2O system by pressing the ec-H2O switch (Figure 83). If cleaning detergent is accidentally cycled through ec-H2O system, a system fault will occur. To clear fault, drain solution tank, add clear water and operate the ec-H2O system to clear fault. If fault repeats, continue to recycle key until fault clears. See SERVICE INDICATOR CODES for further detail.



FIG. 83

3. Lower the squeegee assembly to floor by stepping on foot pedal (Figure 84). To raise squeegee assembly, place foot under foot pedal and lift. The vacuum motor will automatically start when squeegee is lowered to floor.



FIG. 84

- Press the 1-STEP button to activate the scrub function (Figure 85). The scrub head will lower to floor.

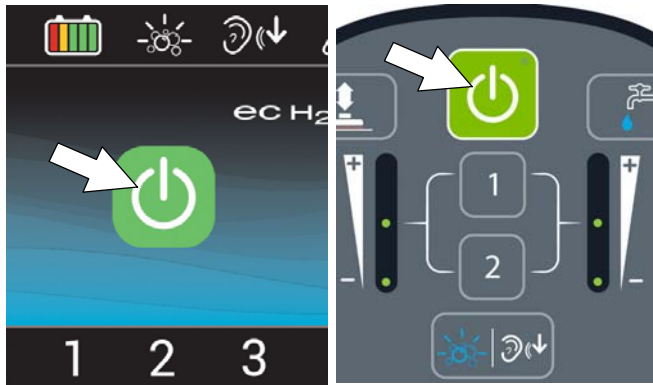

FIG. 85

- Push the directional lever forward to go forward (Figure 86). Pull the lever back to go in reverse. Lift squeegee assembly when reversing.

**FOR SAFETY: Before operating machine, set directional level before pulling start bail.**



FIG. 86

- To begin scrubbing, start out slowly by gradually pulling back on the variable speed control start bail (Figure 87). Slightly let up on the start bail to slow the machine down around corners, near crossings and when approaching tight areas, etc.



FIG. 87

- To adjust the scrubbing speed, turn the speed dial to the desired speed (Figure 88).



FIG. 88

- To stop scrubbing, release the start bail and press the 1-STEP button. Continue to drive machine forward to pick up any remaining water then raise squeegee assembly off floor. Turn key off.

### DOUBLE SCRUBBING

Double scrubbing is the process of making two or more passes over a heavily soiled area. The first pass is made with the squeegee raised off the floor (Figure 89). This allows the solution to penetrate the soiled area for an extended period (3-5 minutes). The second pass is made with the squeegee lowered.

Double scrubbing can be performed using the ec-H2O SCRUBBING SYSTEM (option) or CONVENTIONAL SCRUBBING method.

**FOR SAFETY: When operating machine, wear closed-toe, non-slip shoes and go slowly on inclines and slippery surfaces.**

**FOR SAFETY: When operating machine, follow site safety guidelines concerning wet floors.**

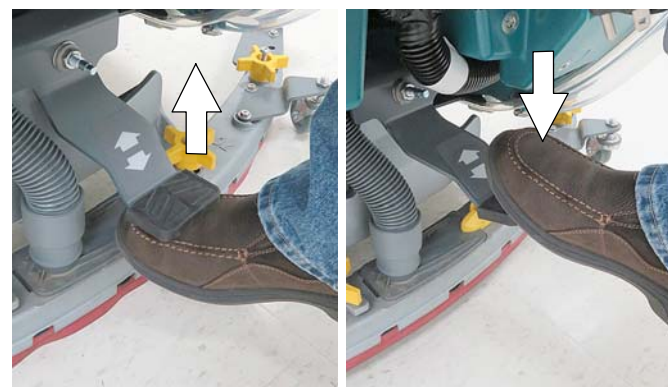

1st pass - squeegee up

2nd pass - squeegee down

FIG. 89

## OPERATION

### EMERGENCY SHUT-OFF BUTTON

Push the emergency shut-off button in the event of an emergency (Figure 90). This red button shuts off all power to machine. To regain power, turn the button clockwise and restart the key.



FIG. 90

### OPERATING SPRAY NOZZLE (T600 Option)

Use spray nozzle for the following. The water supply is provided from the machine's solution tank. If cleaning detergent was added to solution tank, do not use spray nozzle for rinsing purposes.

- Rinse out recovery tank
- Clean squeegee assembly
- Clean scrub head skirt
- Clean brushes and underside of scrub head
- Clean areas above floor (baseboards, etc.)

Do not use spray nozzle in areas where the machine is unable to pick up the excess water, such as off-aisle cleaning. Do not use spray nozzle to clean body of machine.

**FOR SAFETY: When operating machine, do not use spray nozzle for off-aisle cleaning, slip hazard may occur.**

**FOR SAFETY: When servicing machine, do not power spray or hose off machine. Electrical malfunction may occur. Use damp cloth.**

Press the spray nozzle switch to activate spray pump (Figure 91). Press switch again to turn off spray nozzle.

*NOTE: When the spray nozzle switch is activated, machine operation will be disabled.*

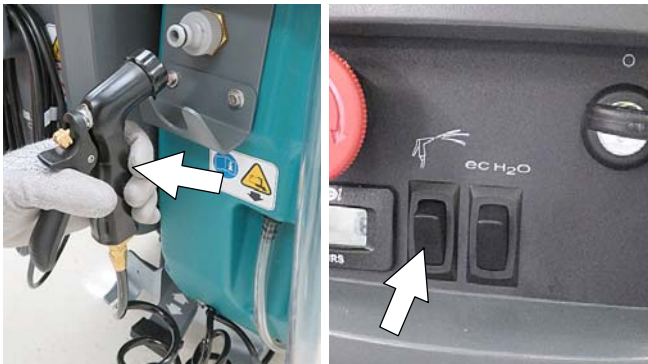

FIG. 91

### WHILE OPERATING MACHINE

**⚠ WARNING: Flammable materials or reactive metals can cause an explosion or fire. Do not pick up.**

1. Overlap each scrub path by 2 inches/5 cm.
2. Keep machine moving to prevent damage to floor finish.

**FOR SAFETY: When operating machine, the machine may only be operated on gradients up to 2%.**

3. Raise scrub head when approaching bumps such as floor transitions and thresholds. If bump height exceeds a half inch (1.27cm) remove scrub disks from machine.
4. Reduce speed around turns, near crossings, and approaching tight areas, etc.
5. Avoid bumping the machine into posts and walls.
6. Wipe squeegee blades with a cloth if blades leave streaks.
7. When draining and refilling machine, always top off the optional Severe Environment tank with detergent.
8. Pour a recommended foam control solution into the recovery tank if excessive foam appears.

**ATTENTION:** Foam buildup will not activate the float shut-off screen, vacuum motor damage will result.

9. Use the double scrubbing method for heavily soiled areas. First scrub the area with the squeegee up, let solution set for 3-5 minutes, then scrub the area a second time with squeegee down.
10. Orbital Scrub Head Model - Use caution when working near the tile cove and floor mounted fixtures such as pedestal sinks and other breakable items. Keep the metal scrub head edge away to avoid possible damage.
11. When leaving the machine unattended, park on level surface, turn machine off and remove key.
12. Do not operate machine in areas where the ambient temperature is above 110°F/43°C or below 36°F/2°C.
13. If machine becomes disable, it can be pushed as described in the PUSHING AND TRANSPORTING MACHINE section.

**CIRCUIT BREAKER PANEL**

The machine is equipped with resettable circuit breakers to protect the machine from a current overload. If a circuit breaker trips, unplug the battery cable connector and reset the breaker by pressing the reset button after the breaker has cooled down. Reconnect the battery cable connection. If the circuit breaker does not reset or continues to trip contact service personnel.

The circuit breaker panel is located below the control console. The circuit breakers are identified as described below (Figure 92).

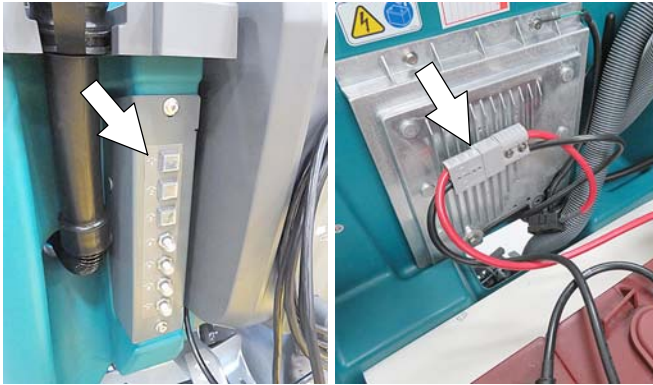

FIG. 92

**T600e Model**

Circuit Breaker	Rating	Circuit protected
CB1	2.5 A	Key switch circuit
CB2	10 A	ec-H2O system, Automatic battery watering system (option)
CB3	10 A	Actuator motor
CB4	40 A	Propel
CB5	25 A	Vacuum fan
CB6	30 A	Left Scrub motor
	30 A	Scrub motor (Orbital model)
CB7	30 A	Right Scrub motor

**T600 Model**

Circuit Breaker	Rating	Circuit protected
CB1	2.5 A	Key switch circuit
CB2	10 A	Control board, ec-H2O system, Automatic battery watering system
CB3	15 A	Spray nozzle pump (option)
CB4	40 A	Propel

**FOR SAFETY: When servicing machine, all repairs must be performed by trained personnel.**

**HOUR METER**

The hour meter records the number of hours the machine has been operated. Use the hour meter to perform specific maintenance procedures and to record service history (Figure 93).



FIG. 93

**DRAINING TANKS**

**FOR SAFETY: Before leaving or servicing machine, stop on level surface, turn off machine and remove key.**

**DRAINING RECOVERY TANK**

Drain and clean the recovery tank after each use.

1. Transport the machine to drain area.
2. For models equipped with drain hose caps, hold the hose upward, remove cap then slowly lower hose to drain. For models equipped with flow control valve drain hose, lower hose and slowly open valve to drain (Figure 94).



FIG. 94

## OPERATION

3. Remove and clean the float shut-off screen (Figure 95). Reinstall screen after cleaning.



FIG. 95

4. Remove the debris tray and empty (Figure 96). Reinstall tray after cleaning.



FIG. 96

5. Rinse out the recovery tank with clean water and wipe clean of any soil residue (Figure 97).



FIG. 97

If machine is equipped with spray nozzle option, use spray nozzle to rinse out recovery tank (Figure 98). The water supply is provided from the machine's solution tank. If cleaning detergent was added to solution tank, do not use spray nozzle for rinsing purposes.

**FOR SAFETY: When servicing machine, do not power spray or hose off machine. Electrical malfunction may occur. Use damp cloth.**



FIG. 98

### DRAINING SOLUTION TANK

Drain the solution tank daily.

1. Transport the machine to drain area.

**FOR SAFETY: Before leaving or servicing machine, stop on level surface, turn off machine and remove key.**

2. To drain remaining water from solution tank, pull the solution tank level hose from the accessory rail (Figure 99). Firmly reconnect the hose to the accessory rail after draining tank.
3. Rinse solution tank with clean water.



FIG. 99

4. Remove the solution tank filter and clean screen after every 50 hours of use (Figure 100). Solution filter is located under machine at rear. Drain solution tank before removing filter.

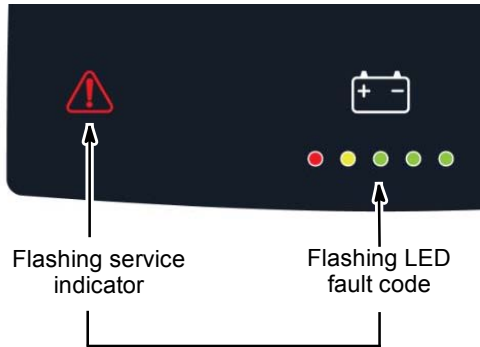

FIG. 100

**SERVICE INDICATOR CODES**

When the machine or battery charger detects a fault, the service indicator will flash. A fault code will be provided to determine problem as described below.

**T600e MODEL SERVICE INDICATOR CODES**



LED Fault Code ☀= Flashing	CAUSE	SOLUTION
☀ ☀ ☀ ☀ ☀	Emergency shut-off button activated Electronic parking brake system is disengaged (option)	Release emergency shut-off button and restart machine See PUSHING AND TRANSPORTING MACHINE
● ☀ ☀ ● ☀	Head lift actuator relay wiring problem	Check connections. Contact service.
● ☀ ● ● ☀	Solution valve wiring, connector or control board problem	Check connections. Contact service
● ☀ ● ☀ ☀	Solution valve over current	Contact service
● ● ☀ ● ●	Brush motor relay wiring, connector or control board problem	Contact service
● ● ☀ ● ☀	Head lift actuator relay wiring, connector or control board problem	Contact service
● ● ☀ ☀ ●	Propel circuit breaker tripped	Reset circuit breaker. If fault repeats, contact service.
● ● ☀ ☀ ☀	Propel motor wiring, connector or control board problem	Contact service
☀ ● ● ● ☀	Propel faults	Restart machine. If fault repeats, contact service.
☀ ● ● ☀ ●	Battery watering pump wiring, connector or control board problem	Contact service
☀ ● ● ☀ ☀	Brush motor relay short fault	Check pad for floor type. If fault repeats contact service.
☀ ● ☀ ● ☀	Start bail is pulled or obstructed before turning machine on	Release start bail or remove bail obstruction before turning machine on.
☀ ● ☀ ☀ ●	Battery watering pump board fault ec-H2O pump control board fault	Disconnect battery cable connection and contact service to replace control board.
☀ ☀ ● ☀ ●	Battery watering system fault	Contact service
● ☀ ☀ ☀ ●	Charger communication fault Scrub control board communication fault ec-H2O system communication fault Battery watering CAN fault	Restart. If fault repeats, contact service.

# OPERATION

## T600 MODEL SERVICE INDICATOR CODES

### Pro-Membrane Control Panel

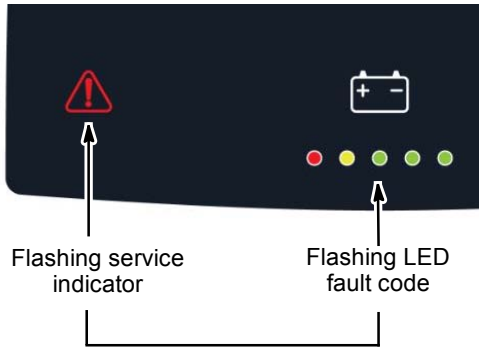

### Pro-Panel Controls (LCD)

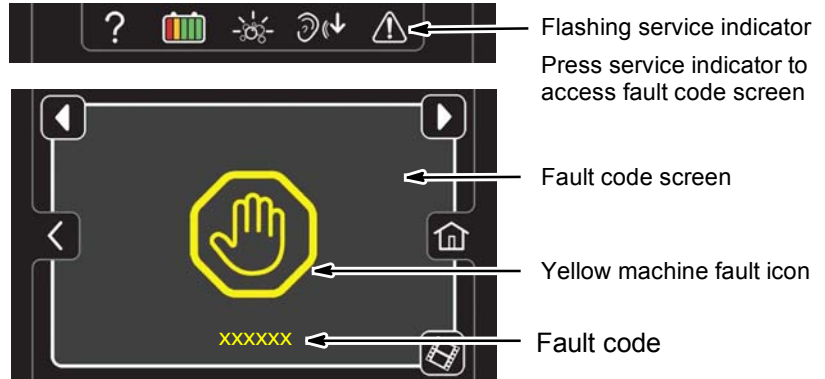

LED Fault Code ☀ = Flashing	LCD Fault Code	CAUSE	SOLUTION
☀ ☀ ☀ ☀ ☀	0xFFF0	Emergency shut-off button activated Electronic parking brake system is disengaged (option)	Release emergency shut-off button and restart machine See PUSHING AND TRANSPORTING MACHINE
• • • ☀ •	0x0201	Head lift actuator, wiring, connector or control board problem	Contact service
• • • ☀ ☀	0x0101 0x0111	Brush motor wiring, connector or control board problem	Contact service
☀ ☀ ☀ ☀ •	0x0102 0x0112	Brush motor 1 voltage loss Brush motor 2 voltage loss	Contact service
• ☀ ☀ • ☀	0x0208	Actuator stalled	Check for blockage. If fault repeats, contact service.
• ☀ • • ☀	0x0301	Solution valve wiring, connector or control board problem	Check connections. Contact service
• ☀ • ☀ ☀	0x0303	Solution valve over current	Contact service
• • ☀ • •	0x0501	Vacuum motor wiring, connector or control board problem	Contact service
• • ☀ • ☀	0x0601	Severe environment detergent pump wiring, connector or control board problem	Contact service
• • ☀ ☀ •	0x1005	Scrub motor under current	Use a more aggressive pad. If fault repeats, contact service.
• • ☀ ☀ ☀	0x0901	Propel motor wiring, connector or control board problem	Contact service
☀ • • • ☀	0x0900 0x0903 0x0904 0x0905 0x0908→0x0950 0x090A→0x093F	Propel I-Drive fault Propel I-Drive communication lost Propel power cycle fault Propel current limit fault Propel faults Propel faults	Reset circuit breaker or restart machine. If fault repeats, contact service.



T600 SERVICE INDICATOR CODES - Continued

LED Fault Code ☀= Flashing	LCD Fault Code	CAUSE	SOLUTION
☀ • • ☀ •	0x0B11	Battery watering pump wiring, connector or control board problem	Contact service
☀ • • ☀☀	0x0103 0x0104 0x0105 0x0109 0x0106	Brush motor 1 over current Brush motor 1 over current Brush motor 1 over current Brush motor 1 over temp fault Brush motor 1 short fault	Check pad for floor type. If fault repeats contact service.  Contact service
☀☀ • ☀☀	0x0113 0x0114 0x0115 0x0119 0x0116	Brush motor 2 over current Brush motor 2 over current Brush motor 2 over current Brush motor 2 over temp fault Brush motor 2 short fault	Check pad for floor type. If fault repeats contact service.  Contact service
☀ • ☀ • ☀	0x0902	Start bail is pulled or obstructed before turning machine on.	Release start bail or remove bail obstruction before turning machine on.
☀ • ☀☀ •	0x0107 0x0117 0x0207 0x0307 0x0507 0x0607 0x0617 0x0B17 0x0717	Brush motor 1 control board fault Brush motor 2 control board fault Actuator motor control board fault Solution valve control board fault Vacuum motor control board fault Detergent pump control board fault Spray pump control board fault Battery watering pump board fault ec-H <sub>2</sub> O pump control board fault	Unplug battery cable connector from battery battery pack and contact service to replace control board.
☀ • ☀☀☀	0x0503 0x0504 0x0505 0x0506	Vacuum motor over current  Vacuum motor shorted fault	Check for obstruction. Contact service.
☀☀ • • •	0x0613 0x0614 0x0615 0x0616	Spray nozzle pump fault	Contact service
☀☀ • • ☀	0x0603 0x0604 0x0605 0x0606	Severe environment detergent pump over current Severe environment detergent pump shorted fault	Contact service
☀☀ • ☀ •	0x0B01 0x0B13-16	Battery watering system fault	Contact service
☀☀☀ • ☀	0x1006	Scrub head imbalance	Check brush wear. Contact service.
• ☀☀☀ •	0xF103 0xFF20  0x0704  0x0B04	Charger communication fault Scrub control board communication fault ec-H <sub>2</sub> O system communication fault Battery watering CAN fault	Restart. If fault repeats, contact service.

# OPERATION

## T600e/T600 ON-BOARD BATTERY CHARGER SERVICE INDICATOR CODES

LED Fault Code ☀ = Flashing	LCD Fault Code	CAUSE	SOLUTION
☀ ☀ ☀ • •	0xF100 0xF104	Charger error condition. Charger timer exceeded maximum charging time Interrupts charging cycle	Contact service Replace batteries
• ☀ ☀ • •	0xF101	Charger is not connected to battery pack	Check cable connections
• ☀ • • •	0xF102	Charger overheated	Let charger cool. Move to well ventilated area. Charge batteries in areas with temperatures 80°F/27°C or less. If fault persists, contact service.
• ☀ ☀ ☀ •	0xF103	Charger communication fault	Restart charger. If fault code persists, contact service.

T600e/T600 ec-H2O SYSTEM SERVICE INDICATOR CODES - OPTION

Membrane Control Panel

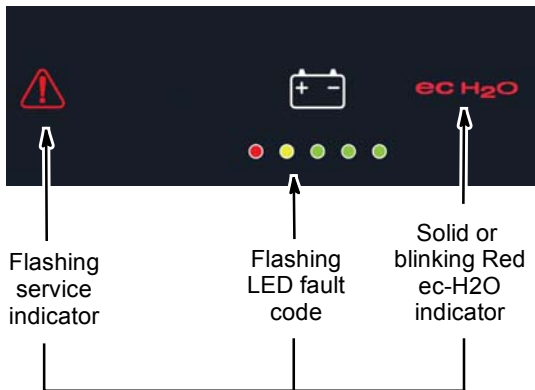

Pro-Panel Controls (LCD)

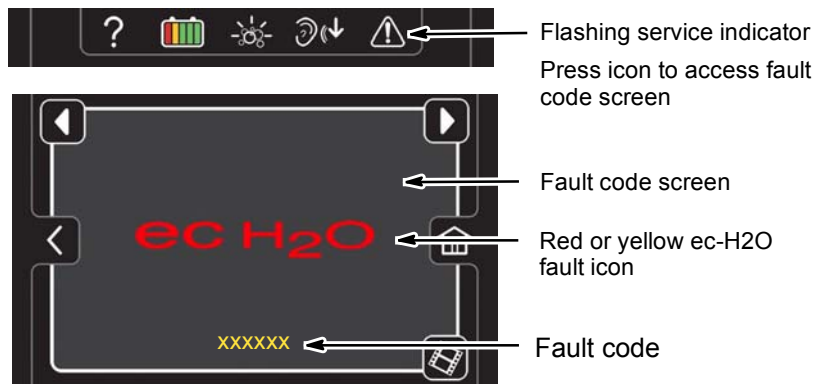

LED Fault Code ☀ = Flashing	LCD Fault Code	CAUSE	SOLUTION
• ☀ • ☀ •	0x0711	ec-H2O pump wiring, connector or control board problem	Contact service
• ☀ ☀ ☀ •	0x0704	ec-H2O system communication fault	Restart. If fault repeats, contact service.
• ☀ ☀ ☀ ☀	0x0713 0x0714 0x0715	ec-H2O pump over current	Contact service
☀ • ☀ • •	0x0703 0x0712	ec-H2O system breaker tripped ec-H2O pump breaker tripped	Reset circuit breaker. If trip repeats, contact service.
ecH2O indicator solid red	0x0716 0x0717 0x0727 0x072A 0x0741 0x0746	ec-H2O pump shorted fault ec-H2O electrical fault ec-H2O control board fault ec-H2O electrode fault Water conditioning pump open Water conditioning pump fault	Contact service
ecH2O indicator blinking red*	0x0702 0x0708* 0x0721 0x0723 0x0726 0x0728 0x0729	ec-H2O pressure switch trip ec-H2O system over regulation No ec-H2O cell current ec-H2O cell over current ec-H2O cell shorted fault ec-H2O cell over regulation ec-H2O cell under regulation	Contact service
ecH2O indicator blinking blue/red	0x0707	Water conditioning cartridge expired	Replace water conditioning cartridge.

\*Verify if cleaning detergent was added to solution tank. If ec-H2O system was operated with cleaning detergent, drain solution tank, add clear water and operate the ec-H2O system until the fault code clears. If fault repeats, continue to recycle key until fault clears.

# MAINTENANCE

## MAINTENANCE CHART

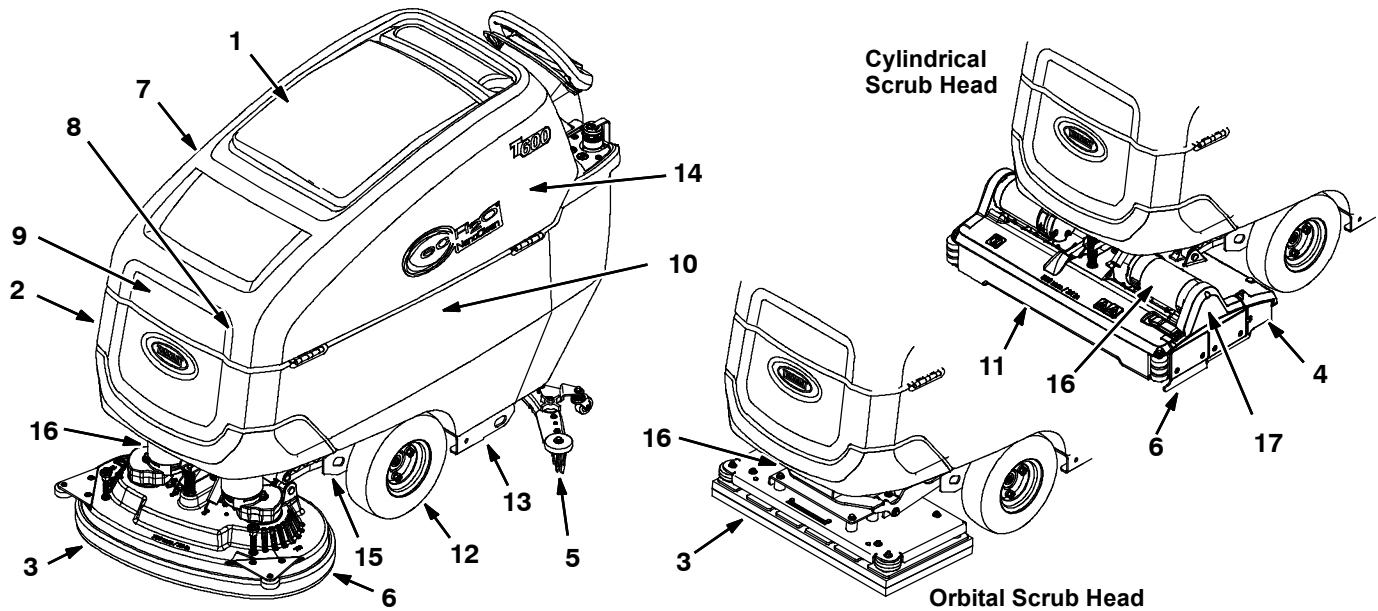

The table below indicates the Person Responsible for each procedure.  
 O = Operator T = Trained Personnel

Interval	Person Resp.	Key	Description	Procedure
Daily	O	1	Recovery tank	Drain, rinse, clean float shut-off screen and debris tray
	O	2	Solution tank	Drain, rinse
	O	3	Pads	Check, flip or replace
	O	3	Brushes	Check, clean
	O	4	Debris trough (Cylindrical Brush)	Clean
	O	5	Squeegee	Clean, check for damage and wear
	O	6	Scrub head skirt	Check for damage and wear
	O	7	Machine	Clean with damp cloth
	O	8	Severe environment tank (option)	Check, refill
	O	9	Automatic battery watering tank (option)	Check, refill
	O	10	Batteries	Charge if necessary
Weekly	O	10	Battery cells	Check electrolyte level
	O	10	Battery compartment	Check for liquid and drain
	O	5	Squeegee assembly drip trap reservoir	Check, clean
50 Hours	O	11	Cylindrical brushes.	Rotate brushes. Check for wear
	O	11	Cylindrical scrub head	Clean underside of scrub head
	O	1	Recovery tank lid seal	Check for wear
	O	2	Solution tank filter	Remove and clean
	O	12	Pneumatic air-filled tires (option)	Check pressure
100 Hours	O	10	Battery watering system (option)	Check hoses for damage and wear
	O	13	Rear casters	Lubricate
200 Hours	O	10	Batteries, terminals and cables	Check and clean
750 Hours	T	14	Vacuum motor	Replace carbon brushes
1250 Hours	T	15	Propel motor	Replace carbon brushes
	T	16	Brush motor	Replace carbon brushes
	T	17	Brush belt (Cylindrical Brush)	Replace belt

## MACHINE MAINTENANCE

To keep the machine in good working condition, simply perform the following maintenance procedures.

**FOR SAFETY: Before leaving or servicing machine, stop on level surface, turn off machine and remove key.**

**FOR SAFETY: When servicing machine wear personal protection equipment as needed. All repairs must be performed by trained personnel**

### YELLOW TOUCH POINTS

This machine is equipped with easy to find yellow touch points for simple service items. A few examples shown below (Figure 101). No tools are required to perform these maintenance operations.

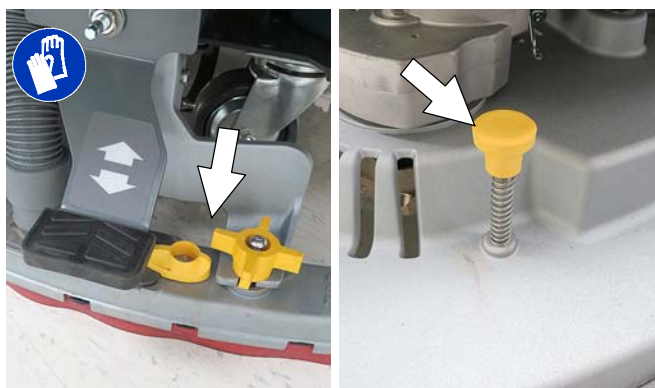

FIG. 101

### AFTER DAILY USE

1. Drain and rinse out the recovery tank (Figure 102). See DRAINING TANKS.



FIG. 102

If machine is equipped the spray nozzle option, use spray nozzle to rinse out recovery tank (Figure 103). If cleaning detergent was added to solution tank, do not use spray nozzle for rinsing purposes.

**FOR SAFETY: When servicing machine, do not power spray or hose off machine. Electrical malfunction may occur. Use damp cloth.**



FIG. 103

2. Remove the debris tray and empty (Figure 104). Reinstall tray after cleaning.



FIG. 104

3. Remove and clean the float shut-off screen (Figure 105). Reinstall screen after cleaning.



FIG. 105

# MAINTENANCE

4. Drain and rinse out the solution tank (Figure 106).



FIG. 106

5. Disk scrub head - Turn pad over or replace when worn (Figure 107).

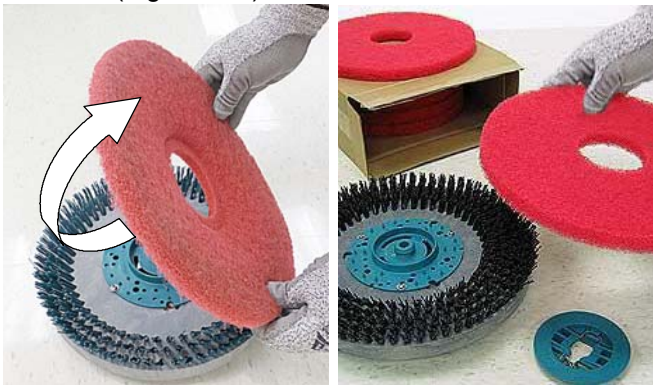

FIG. 107

6. Replace brushes when they no longer clean effectively or when the bristles are worn to the yellow indicator (Figure 108).



FIG. 108

- Orbital scrub head - Turn the working pad over or replace when worn (Figure 109).

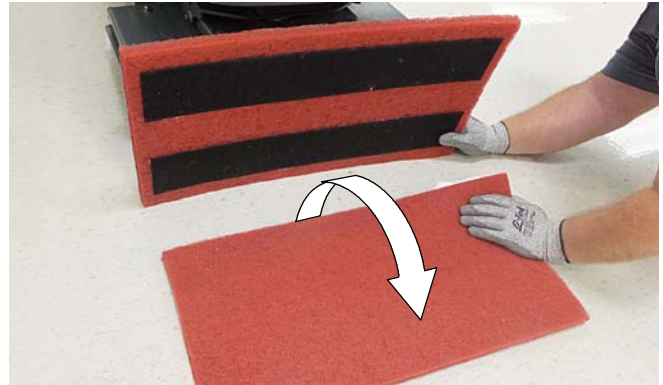

FIG. 109

7. Wipe the squeegee blades clean. Inspect blades for wear and damage (Figure 110). Rotate blade if worn. See SQUEEGEE BLADE REPLACEMENT.



FIG. 110

8. Clean scrub head skirt. Check for wear or damage (Figure 111). Replace if worn or damaged.



FIG. 111

9. Clean the outside surface of the machine with an all purpose cleaner and damp cloth (Figure 112).

**FOR SAFETY: When servicing machine, do not power spray or hose off machine. Electrical malfunction may occur. Use damp cloth.**



**FIG. 112**

10. Cylindrical brush scrub head - Remove and clean debris trough (Figure 113).



**FIG. 113**

11. Severe environment option - Refill the severe environment tank with a recommended cleaning detergent at full concentration (Figure 114). Replace cap.

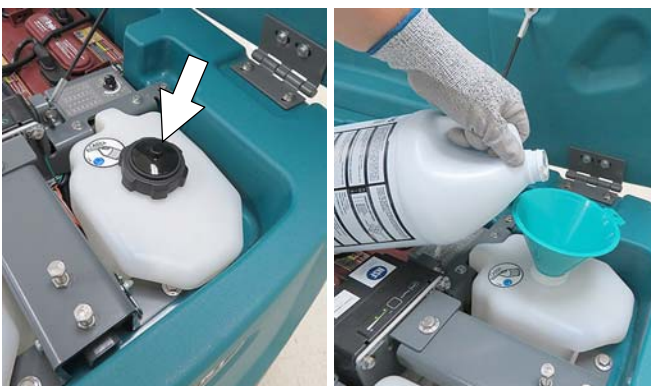

**FIG. 114**

12. Automatic battery watering option - Refill tank with distilled water (Figure 115). Replace cap.

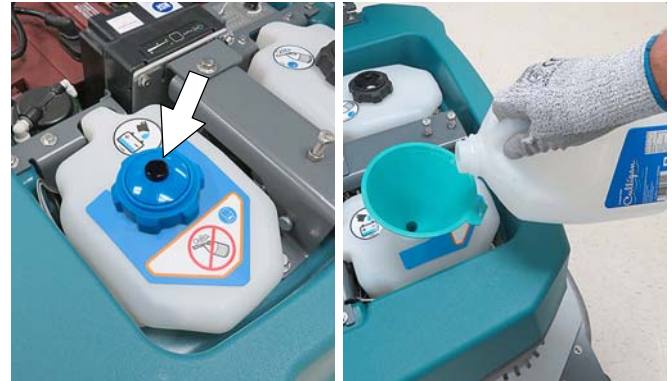

**FIG. 115**

13. Charge batteries (Figure 116). See BATTERIES.

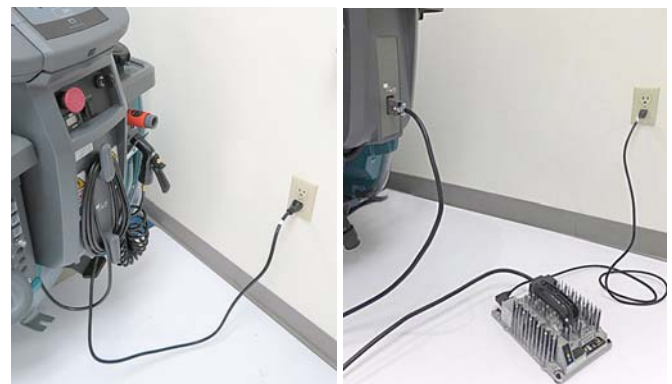

**FIG. 116**

**ATTENTION: Do not disconnect battery cables while charger is plugged in, circuit board damage may result.**

**AFTER WEEKLY USE**

1. Check the electrolyte level in each battery cell (Figure 117). See BATTERIES.

*NOTE: If machine is equipped with the automatic or manual battery watering system, See BATTERIES.*

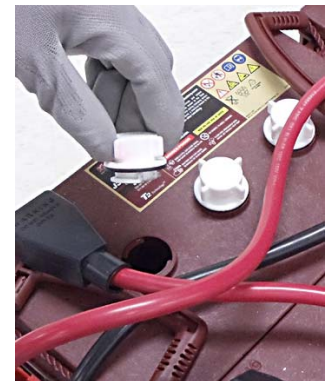
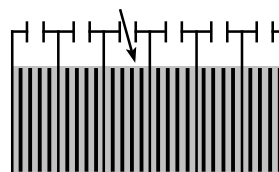

**FIG. 117**

## MAINTENANCE

2. Check for liquid in the battery compartment. (Figure 117). See BATTERY COMPARTMENT DRAIN HOSE for further details.

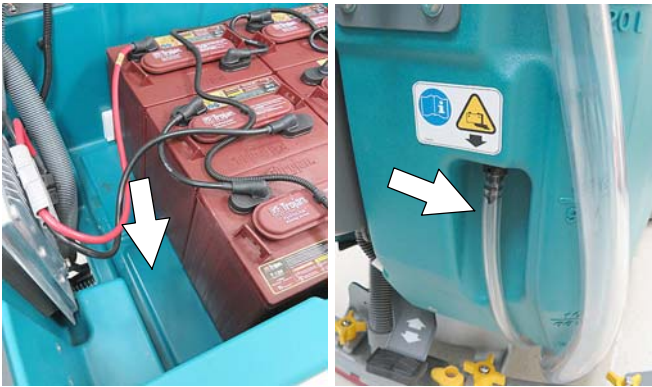

FIG. 118

3. Remove the drip trap cover from the squeegee assembly and clean reservoir (Figure 119).



FIG. 119

### AFTER EVERY 50 HOURS OF USE

1. Drain solution tank. Remove the solution tank filter and clean screen (Figure 120). Turn the filter bowl counter-clockwise to remove.



FIG. 120

2. Inspect and clean the seal on the recovery tank lid (Figure 121). Replace seal if damaged.



FIG. 121

3. Cylindrical brushes - Rotate brushes from front to rear (Figure 122). Replace brushes when they no longer clean effectively.

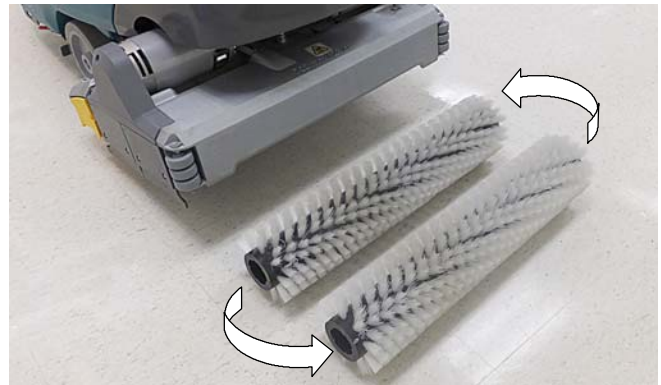

FIG. 122

4. Check tire pressure if equipped with the pneumatic (air-filled) tires (Figure 123). The proper tire pressure is 60 to 65 psi (415 to 450 kPa).

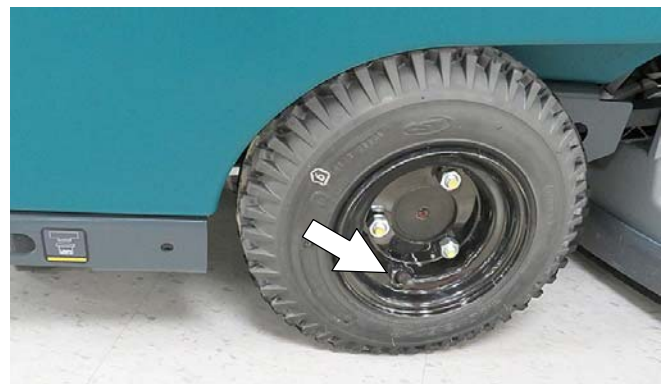

FIG. 123



- Cylindrical scrub head - Remove debris buildup from underside of scrub head, including the idler plates and drive hubs (Figure 124).

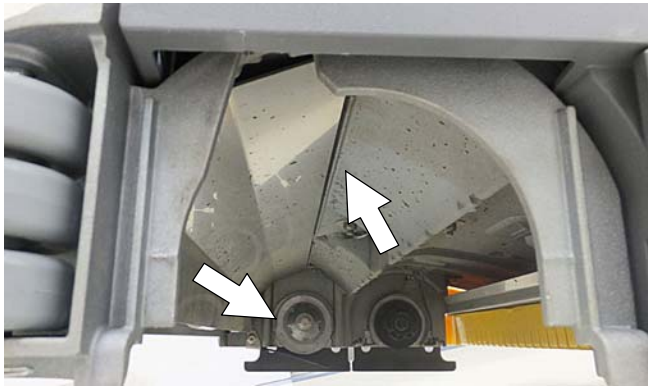

FIG. 124

**AFTER EVERY 100 HOURS OF USE**

If machine is equipped with the optional battery watering system, check hoses for leaks, loose hose connections and for damage or wear (Figure 125). Replace system if damaged.

**FOR SAFETY: When servicing batteries, wear personal protection equipment as needed. Avoid contact with battery acid.**



FIG. 125

Lubricate rear casters with a grease gun. Use Lubriplate EMB grease (Tennant part no. 01433-1) (Figure 126).



FIG. 126

**AFTER EVERY 200 HOURS OF USE**

Check batteries for loose battery connections and clean the surface of the batteries, including terminals and cable clamps to prevent corrosion (Figure 125). See BATTERIES.

**FOR SAFETY: When servicing batteries, wear personal protection equipment as needed. Avoid contact with battery acid.**



FIG. 127

**ELECTRIC MOTORS**

Replace motor carbon brushes as indicated. Contact trained personnel for carbon brush replacement.

Carbon Brush Replacement	Hours
Vacuum motor	750
Propel motor	1250
Disk brush motors	1250
Cylindrical brush motors	1250
Orbital brush motor	1250

**BELTS (Cylindrical Brush Model)**

**FOR SAFETY: Before leaving or servicing machine, stop on level surface, turn off machine and remove key.**

Replace belts every 1250 hours. Contact trained personnel for belt replacement (Figure 128).

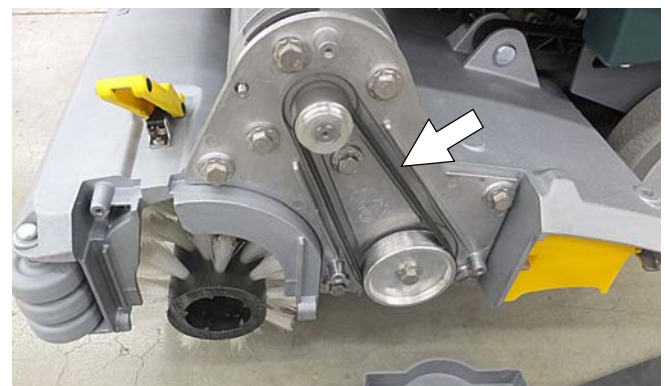

FIG. 128

# MAINTENANCE

## BATTERIES

**FOR SAFETY: Before servicing machine, stop on level surface, turn off machine and remove key.**

Your machine is equipped with either flooded (wet) lead-acid or maintenance-free (Sealed AGM) batteries supplied by Tennant.

The lifetime of the batteries depends on their proper maintenance. To get the most life from the batteries:

- Do not charge the batteries more than once a day and only after running the machine for a minimum of 15 minutes.
- Do not leave the batteries partially discharged for long period of time.
- Only charge the batteries in a well-ventilated area to prevent gas build up.
- Allow the charger to complete charging the batteries before re-using the machine.
- Maintain the proper electrolyte levels of flooded (wet) batteries by checking battery cell levels weekly.

**FOR SAFETY: When servicing machine, battery installation must be done by trained personnel.**

**FOR SAFETY: When servicing machine, keep all metal objects off batteries. Avoid contact with battery acid.**

### MAINTENANCE-FREE BATTERIES

Maintenance-free (Sealed AGM) batteries do not require watering. Cleaning and other routine maintenance is still required.

### FLOODED (WET) LEAD-ACID BATTERIES

The flooded (wet) lead-acid batteries require routine watering as described below. Check the battery electrolyte level weekly.

*NOTE: If machine is equipped with the automatic or manual battery watering system, proceed to the BATTERY WATERING SYSTEM instructions.*

The electrolyte level should be slightly above the battery plates as shown before charging (Figure 129). Add distilled water if low. DO NOT OVERFILL. The electrolyte will expand and may overflow when charging. After charging, distilled water can be added up to about 3 mm (0.12 in) below the sight tubes.

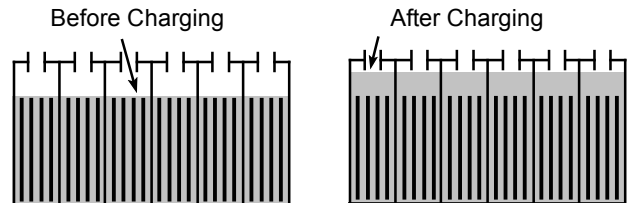
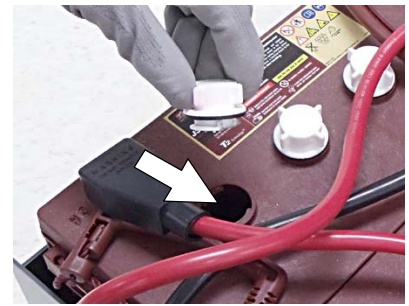

FIG. 129

*NOTE: Make sure the battery caps are in place while charging. There may be a sulfur smell after charging batteries. This is normal.*

### CHECKING CONNECTIONS / CLEANING

After every 200 hours of use, check for loose battery connections and clean the surface of the batteries, including terminals and cable clamps to prevent battery corrosion. Use a scrub brush with a strong mixture of baking soda and water (Figure 130). Do not remove battery caps when cleaning batteries.



FIG. 130

**CHARGING BATTERIES**

The charging instructions in this manual are intended for the battery charger supplied with your machine. The use of other battery chargers that are not supplied and approved by Tennant are prohibited.

If your machine is equipped with an off-board battery charger refer to the charger owners manual for operating instructions. Contact distributor or Tennant for battery charger recommendations.

**FOR SAFETY: The use of incompatible battery chargers may damage battery packs and potentially cause a fire hazard.**

**IMPORTANT NOTICE:** The battery charger is set to charge the battery type supplied with your machine. If you choose to change to a different battery type or capacity (i.e. flooded (wet) lead-acid, maintenance-free, sealed, AGM batteries, etc.), the charger's charging profile must be changed to prevent battery damage. See BATTERY CHARGER SETTINGS.

1. Transport the machine to a well-ventilated area.

**⚠ WARNING: Batteries emit hydrogen gas. Explosion or fire can result. Keep sparks and open flame away when charging.**

2. Park the machine on a flat, dry surface, turn off machine and remove key.

**FOR SAFETY: Before leaving or servicing machine, stop on level surface, turn off machine and remove key.**

3. If the machine is equipped with flooded (wet) lead-acid batteries check the battery electrolyte level weekly before charging. For models equipped with the automatic battery watering system, check if the automatic battery water tank needs refilling. Add distilled water if low.
4. For models equipped with an on-board charger, remove the charger's power cord from the storage hooks and plug power cord into a properly grounded wall outlet (Figure 131).



FIG. 131

For models equipped with off-board chargers, first connect the charger's DC cord into the machine's battery charge receptacle then plug the AC power supply cord into a properly grounded wall outlet (Figure 132). Refer to the off-board battery charger owners manual for operating instructions.

**FOR SAFETY: Do not disconnect the off-board charger's DC cord from the machine's receptacle when the charger is operating. Arcing may result. If the charger must be interrupted during charging, disconnect the AC power supply cord first.**

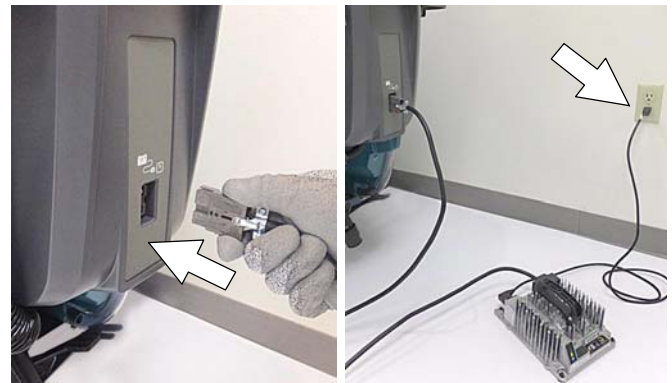

FIG. 132

5. The charger will automatically begin charging and shut off when fully charged. The maximum charging cycle may take up to 6-12 hours depending on battery type.

On-board battery charger: The battery discharge indicator lights will ripple back and forth during the charging cycle. When all five lights repeatedly flash two times, the charging cycle is complete (Figure 133).



FIG. 133

**ATTENTION: Do not disconnect battery cables while charger is plugged in, circuit board damage may result.**

6. After charging batteries unplug the power supply cord and wrap cord around the cord hooks.

For models equipped with an off-board charger, always disconnect the AC power supply cord first before disconnecting charger from machine.

## BATTERY CHARGER SETTINGS

The battery charger is set to charge the battery type supplied with your machine. If you choose to change to a different battery type or capacity, the charger's charging profile must be changed to prevent battery damage.

The machine must also be reprogrammed to match battery type to prevent battery damage and/or short run-time.

*NOTE: For machines shipped without batteries, the machine and the on-board battery charger are set for GEL batteries as the default. If you choose to use a different battery type, the settings must be changed as described as below.*

*NOTE: For machines shipped without batteries and supplied with an Off-Board Charger, the off-board battery charger is set for 180-240 AH wet lead-acid batteries from the factory. The machine is set for GEL batteries as the default. The machine must be reprogrammed to match charger settings (See OFF-BOARD BATTERY CHARGER below).*

**IRIS MODELS:** For models equipped with capability to report battery charging data via IRIS, Tennant recommends using the same battery type. If a different amp hour or battery type is desired, contact Tennant Service Department.

### OFF-BOARD BATTERY CHARGER:

- To change the off-board battery charger settings, see OFF-BOARD BATTERY CHARGER SETTINGS.
- To reprogram the machine to match the off-board charger setting, see below:

**T600e Membrane and T600 Pro-Membrane Models** - Service application software required, contact service.

**T600 Pro-Panel Model** - See SELECTING BATTERY TYPE.

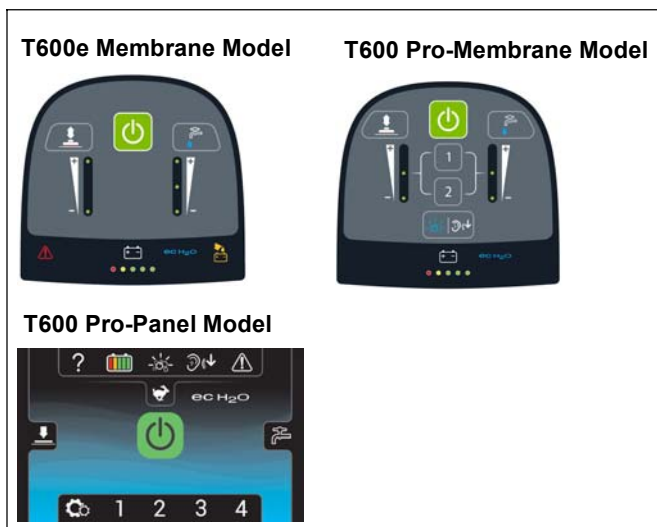

### OFF-BOARD BATTERY CHARGER SETTINGS:

*NOTE: The following instructions are intended for Delta-Q off-board charger model RC-900-U36 supplied by Tennant.*

- To display the current profile setting, press and release the Select Charge Profile Button (Figure 134). The profile setting is indicated by the number of consecutive green flashes after the initial two red flashes. This code is repeated twice.

ex. Profile Setting 3: (Flashes: Red-Red-Green-Green-Green)

ex. Profile Setting 4-3: (Flashes: Red-Red, Green-Green-Green-Green - pause - Green-Green-Green)



FIG. 134

- To enter the battery select mode to choose a new profile setting, press and hold the Select Charge Profile Button for 5 seconds. Fast red flashes will confirm select mode entry.
- Indicator will then display current profile setting. This is repeated 4 times.
 

ex. Profile Setting 3: (Flashes: Red-Red-Yellow-Yellow-Yellow)
- To change profile setting, press the Select Charge Profile Button while the current setting is repeating 4 times. Continue to press button until desired profile setting is flashing as described in table.

Profile setting	Battery Description
3	Wet, Trojan 180-240 AH
7	Wet, Trojan 270-360 AH
2-1	Wet, TAB/Energys 180-260 AH
2-8	Gel, Deka 180-200 AH
4-3	AGM, Discover 200-400 AH
5-1	Gel, Sonnenschein 150-250 AH
1-6-8	TPPL, 12XFC48 / 12XFC58 / 12XFC60

- To save new setting, press the button for 7 seconds until new setting is displayed by green flashes. The new setting will repeat two times with two red flashed between repeats.
- Confirm new setting by repeating step 1.

**ON-BOARD BATTERY CHARGER:**

**T600e Membrane and T600 Pro-Membrane Models -** To change the on-board battery charger settings and to reprogram the machine's battery discharge indicator, service application software is required. Contact service.

**T600 Pro-Panel Model -** To change the on-board battery charger settings, see *SELECTING BATTERY TYPE*. The battery discharge indicator will automatically reprogram to match battery selection.

**SELECTING BATTERY TYPE  
(T600 Pro-Panel model)**

*NOTE: To perform this procedure, machine must be in supervisor mode. See SUPERVISOR CONTROLS instructions at back of manual.*

1. Turn the key to the on position.
2. Press the settings button located on the home screen (Figure 135).



FIG. 135

3. Press the Battery Type button (Figure 136).

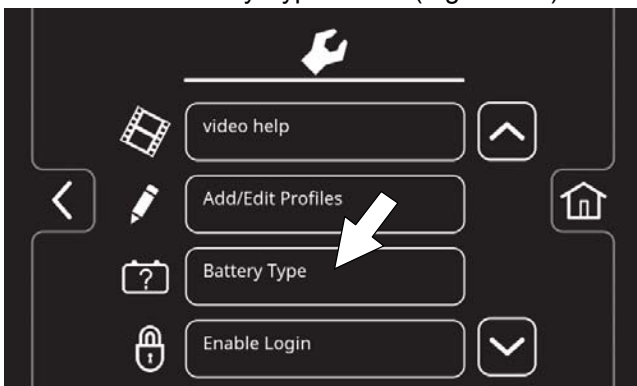

FIG. 136

4. Select battery type and brand installed in machine (Figure 137). See battery label to determine type and brand. Press the up and down arrows to scroll through battery selection.

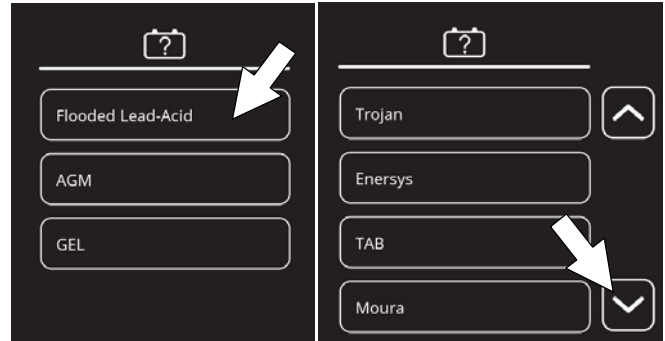
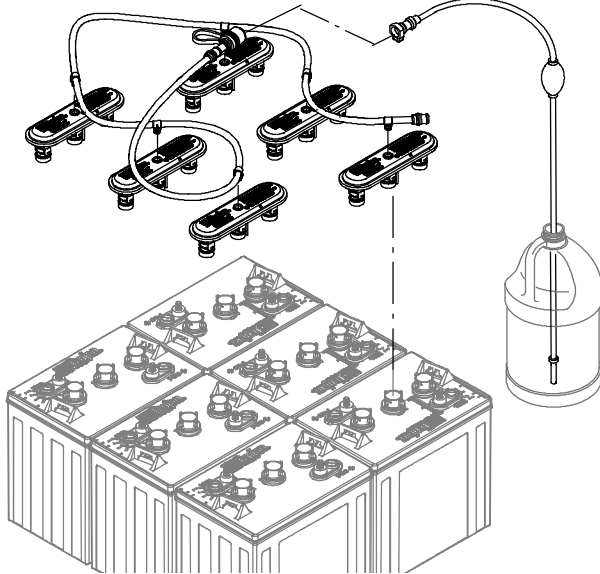

FIG. 137

*NOTE: The battery charger profile and battery discharge indicator will automatically reprogram when battery type is selected.*

**HYDROLINK® BATTERY WATERING SYSTEM  
(Trojan® Battery OPTION)**

The following instructions are for models equipped with the HydroLink battery watering system option.



The optional HydroLink battery watering system provides a safe and easy way to maintain the proper electrolyte levels in your batteries. It is designed exclusively for Trojan flooded (wet) lead-acid batteries.

**FOR SAFETY: When servicing machine, wear personal protection equipment as needed. Avoid contact with battery acid.**

Before using the battery watering system check hoses and connections for damage or wear.

1. Fully charge batteries prior to using the battery watering system. Do not add water to batteries before charging, the electrolyte level will expand and may overflow when charging.
2. After charging batteries, check the battery electrolyte level indicators located on the battery covers (Figure 138). If the level indicator is white add water as described in the following instructions. If the level indicators are black the electrolyte is at the correct level, no water is required.



**FIG. 138**

3. Locate the battery fill hose coupler inside the battery compartment. Remove the dust cap and connect the hand pump hose (Figure 139).

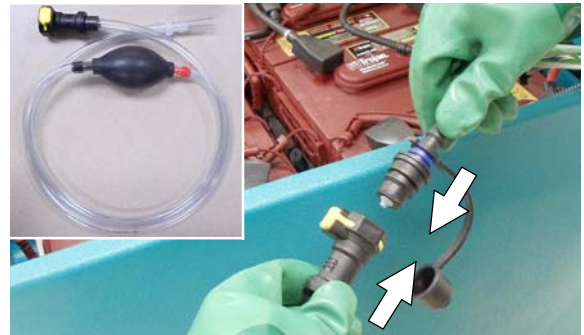

**FIG. 139**

4. Submerge the other end of the hand pump hose into a bottle of distilled water (Figure 140).



**FIG. 140**

5. Squeeze the bulb on the hand pump hose until firm (Figure 141). The level indicators will turn black when full.

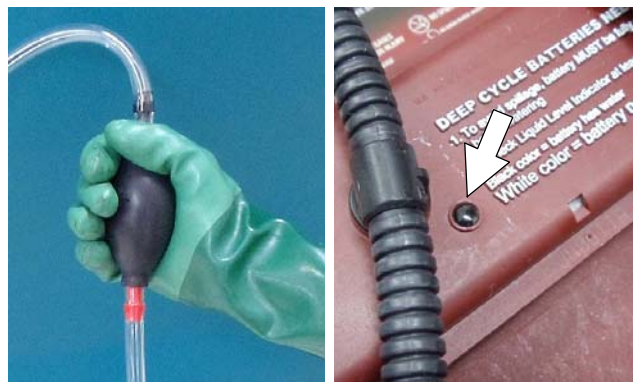

**FIG. 141**

6. After adding water, replace the dust cap on the battery fill hose and store the hand pump hose inside the machine's battery compartment for future use.

**AUTOMATIC BATTERY WATERING SYSTEM (Trojan® Battery OPTION)**

**FOR SAFETY: Before leaving or servicing machine, stop on level surface, turn off machine and remove key.**

The automatic battery watering system is designed to automatically refill the batteries after the machine reaches a limited number of charge cycles. Do not remove battery caps and manually add water to the batteries.

Check the automatic battery watering system for leaks, loose hose connections and for damage or wear. (Figure 142). Replace if damaged.



FIG. 142

Check the water level in the automatic watering tank periodically. Add distilled water when low (Figure 143).

**FOR SAFETY: When servicing machine, only use distilled water when filling the automatic battery watering tank.**

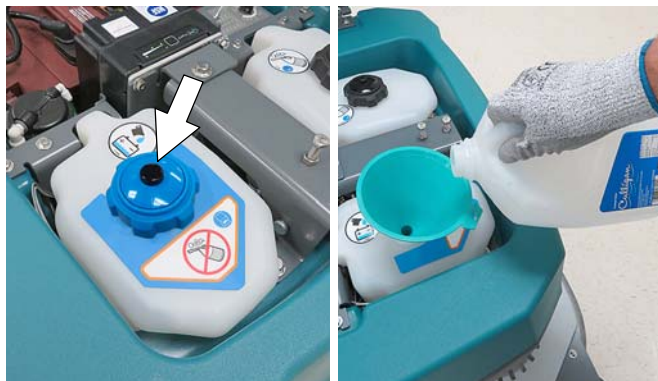

FIG. 143

The automatic battery watering indicator will also alert user to add distilled water when tank is empty (Figure 144). See CONTROL PANEL OPERATION for further details.

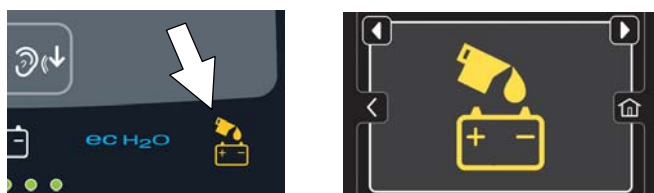

FIG. 144

**BATTERY COMPARTMENT DRAIN HOSE**

Use the battery compartment drain hose to drain liquid from the battery compartment.

**FOR SAFETY: Before leaving or servicing machine, stop on level surface, turn off machine and remove key.**

**FOR SAFETY: When servicing machine, always follow site safety rules when disposing battery compartment liquid.**

1. Position rear of machine over area where battery compartment can be safely drained, turn off the machine, and remove the key.
2. Pull the battery compartment drain hose from hose holder and carefully drain liquid from battery compartment (Figure 145).

**FOR SAFETY: When servicing machine, wear personal protection equipment as needed. Avoid contact with battery acid.**

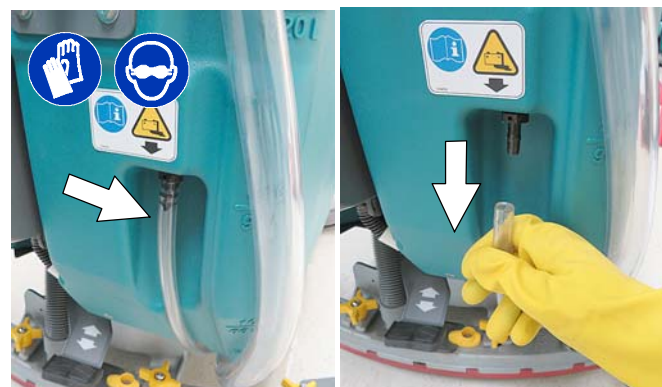

FIG. 145

3. Firmly reconnect the drain hose to holder after draining battery compartment.

## SQUEEGEE BLADE REPLACEMENT

**FOR SAFETY:** Before leaving or servicing machine, stop on level surface, turn off machine and remove key.

Each squeegee blade has four wiping edges. When the blades become worn, simply rotate the blades end-for-end or top-to-bottom for a new wiping edge. Replace blade if all four edges are worn.

1. Remove the squeegee assembly from the machine.
2. Fully loosen the two outside knobs on squeegee assembly. This will separate the spring loaded blade retainer from squeegee frame (Figure 146). To loosen the knobs quickly, squeeze the blade retainer and squeegee frame together.

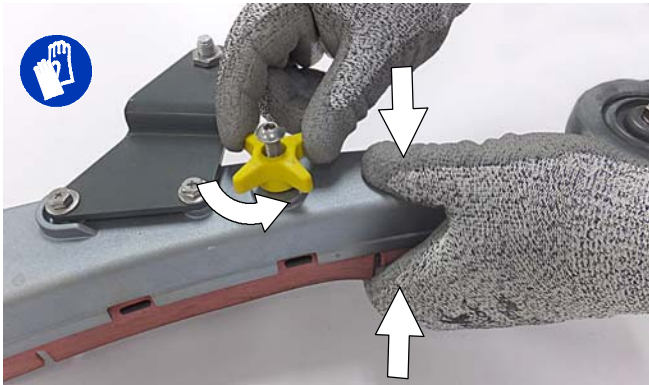

FIG. 146

3. Remove worn blade(s) from the blade retainer (Figure 147).



FIG. 147

4. Rotate the rear blade to a new wiping edge and reinstall blade (Figure 148). Make sure to align the slots in the blade with retainer tabs.

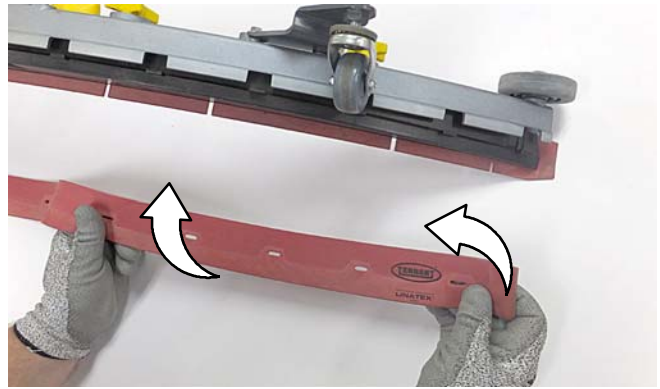

FIG. 148

5. Squeeze the squeegee frame and blade retainer together and re-tighten the two outside knobs (Figure 149).

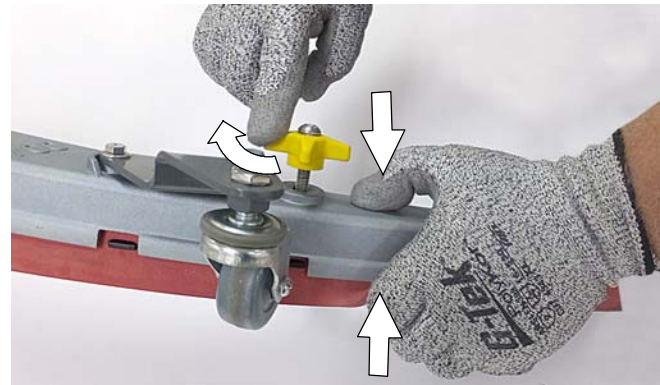

FIG. 149



## ec-H2O WATER CONDITIONING CARTRIDGE REPLACEMENT

**FOR SAFETY:** Before leaving or servicing machine, stop on level surface, turn off machine and remove key.

The water conditioning cartridge is required to be replaced when it reaches its maximum water usage or expiration time of when the cartridge was activated, whichever comes first. The control panel will signal a code when it's time to replace cartridge. See CONTROL PANEL OPERATION for further details.

Depending on machine usage, on average, a new cartridge can last anywhere from 12 months for heavy machine usage to 24 months for light machine usage.

**ATTENTION:** During first time use and after replacing the water conditioning cartridge, the ec-H2O system will automatically override the selected solution flow rate for up to 75 minutes.

1. Park the machine on a level surface and remove the key.
2. Lift the recovery tank to access the ec-H2O water conditioning cartridge (Figure 150). Drain recovery tank before lifting tank.



FIG. 150

3. Disconnect the two hose connectors from the top of the cartridge by pressing the gray collars inward and pulling the connectors outward (Figure 151). Lift cartridge to remove.

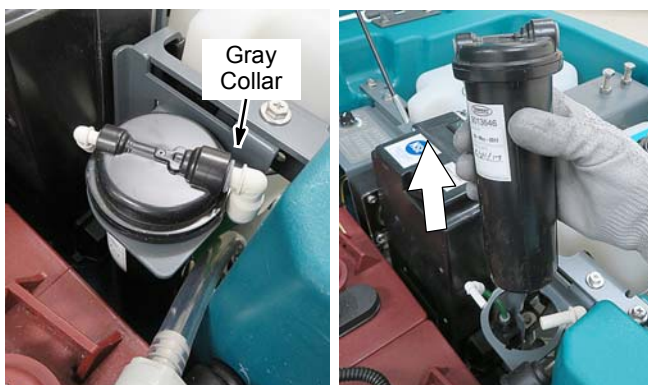

FIG. 151

4. Fill in the installation date on the new cartridge label (Figure 152).



FIG. 152

5. Install the new cartridge and reconnect the two hoses. Make sure the hose connectors are fully inserted into the cartridge.
6. Reset timer for new cartridge.

Carefully read and understand all steps first before performing procedure.

- a. Turn key on.
- b. Press and hold the service switch, located on the ec-H2O module, for 10 seconds. After releasing service switch, the three solution flow indicator lights will begin to (ripple) move back and forth (Figure 153).
- c. Within 5 seconds after releasing the service switch, while the three indicator lights are moving back and forth, quickly press and release the solution flow button located on ec-H2O module (Figure 153). The three indicator lights will then blink three times to indicate timer has been reset. Repeat process if the three indicator lights do not blink three times.

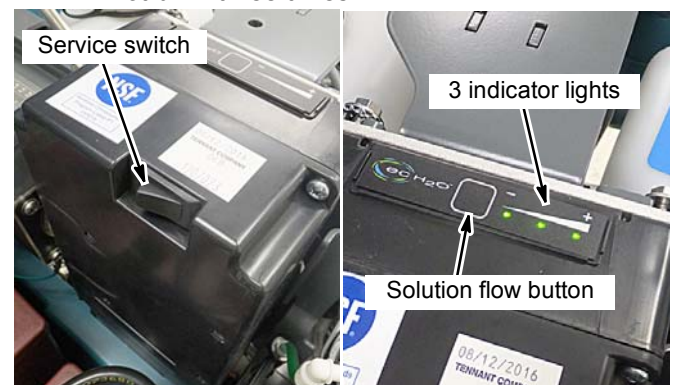

FIG. 153

## MAINTENANCE

### MACHINE JACKING

**FOR SAFETY:** Before leaving or servicing machine, stop on level surface, turn off machine and remove key.

Use the designated locations to jack up the machine for service (Figure 154). Empty the recovery and solution tanks and position the machine on a level surface before jacking. Stay clear from the solution tank filter bowl when jacking.

**FOR SAFETY:** When servicing machine, jack machine up at designated locations only. Support machine with jack stands. Use jack or hoist that will support the weight of the machine.

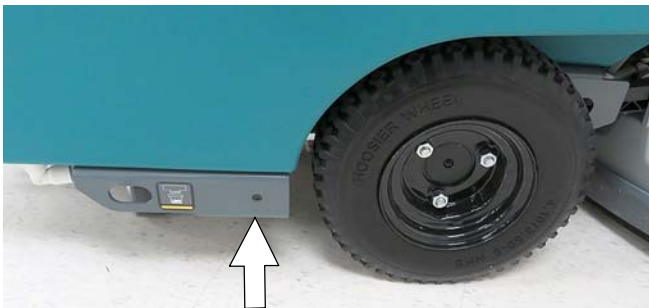

FIG. 154

### PUSHING AND TRANSPORTING MACHINE

#### PUSHING MACHINE

If the machine becomes disabled, it can be pushed as describe below.

Only push the machine for a very short distance and do not exceed 3.2 kp/h (2 mph). It is not intended to be pushed for a long distance or at a high speed.

For models equipped with an electronic parking brake system, the brake must be disengaged before pushing machine. To disengage brake, position the brake lever on the transaxle to the down position (Figure 155).

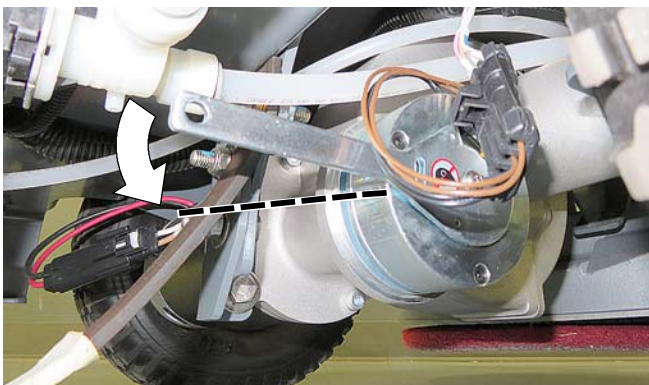

FIG. 155

**ATTENTION:** Do not push machine for a long distance or damage may occur to the propelling system.

Immediately after pushing the machine, re-engage the brake lever to prevent a roll hazard.

**NOTE:** When brake lever is disengaged, the propel will be disabled and a fault will be detected until lever is re-engaged.

**FOR SAFETY:** When servicing machine, do not push the machine on inclines with brake disabled.

#### TRANSPORTING MACHINE

When transporting the machine by use of trailer or truck, carefully follow loading and tie-down procedure:

1. Drain tanks, raise scrub head and remove scrub disks and squeegee assembly.
2. Carefully load machine in trailer or on truck.

**FOR SAFETY:** When loading/unloading, use a ramp that can support the machine weight and operator.

**FOR SAFETY:** When loading/unloading, the machine may only be operated on gradients up to 2%.

3. Once loaded, position the front of the machine up against the front of the trailer or truck. Lower the scrub head and turn key off.
4. Place a block behind each wheel (Figure 156).
5. Using tie-down straps, secure the machine using the four tie-down brackets located on the machine frame (Figure 156). It may be necessary to install tie-down brackets to the floor of your trailer or truck.

**NOTE:** When transporting machine in an open truck or trailer, secure recovery tank lid.

**ATTENTION:** Do not use control console area or accessory rails for tie-down locations, damage may occur.

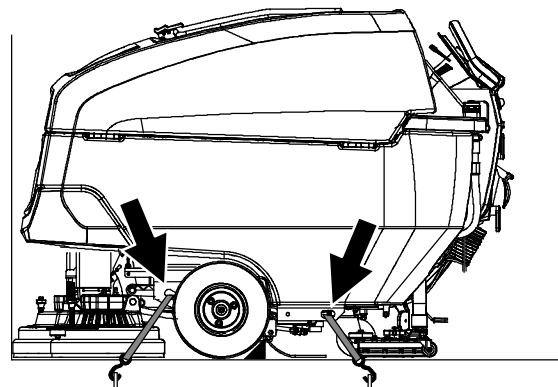
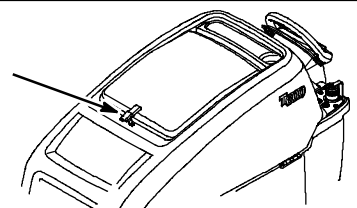

FIG. 156

Optional Transport Kit  
Part No. 9042166  
Recovery Tank Lid Latch



## STORING MACHINE

The following steps should be taken when storing the machine for extended periods of time.

1. Charge the batteries before storing machine to prolong the life of the batteries. Recharge batteries once a month.
2. Disconnect batteries before storing.
3. Drain and rinse recovery tank and solution tank.
4. Store the machine in a dry area with squeegee and scrub head in the up position.

**ATTENTION: Do not expose machine to rain, store indoors.**

5. Open the recovery tank lid to promote air circulation.
6. If storing machine machine in freezing temperatures, proceed to FREEZE PROTECTION.

*NOTE: To prevent potential machine damage store machine in a rodent and insect free environment.*

## FREEZE PROTECTION

Storing machine in freezing temperatures.

1. Completely drain solution tank and recovery tank.
2. Empty the water from the solution tank filter located under machine. Replace filter (Figure 157).



FIG. 157

3. Pour 1 gallon / 4 liters of propylene glycol based recreational vehicle (RV) antifreeze into the solution tank.

Models equipped with optional Severe Environment detergent tank - Lift tank from machine and empty the detergent from tank (Figure 158). Return tank. Pour a 1/4 gallon / 1 liter of propylene glycol based recreational vehicle (RV) antifreeze into the detergent tank.

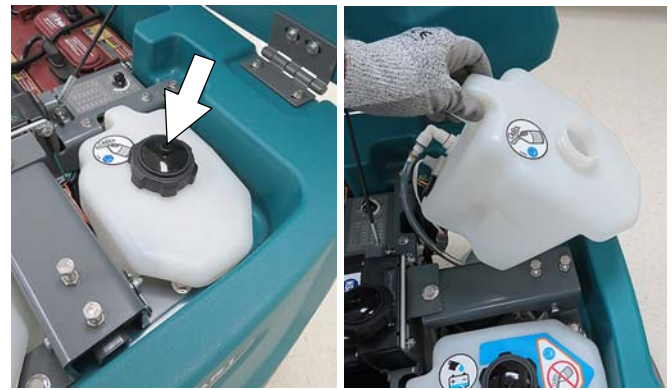

FIG. 158

4. Models not equipped with ec-H2O system - Turn machine on and operate the solution flow system. Turn the machine off when the antifreeze is visible on the floor.  
Models equipped with ec-H2O system and Severe Environment mode - Set the detergent ratio dial to the highest flow rate. Turn machine on and set solution flow rate to high. Operate ec-H2O scrubbing and press the severe environment button to cycle the antifreeze through both systems. Turn machine off when antifreeze is visible on the floor. This may take up to two minutes.
5. Models equipped with ec-H2O system - Turn machine on and set the solution flow rate to high and operate ec-H2O scrubbing to cycle antifreeze through system. Turn machine off when antifreeze is visible on the floor. This may take up to two minutes.  
Models equipped with spray nozzle option - Operate the spray nozzle to cycle antifreeze through pump.
5. Models equipped with optional automatic battery watering tank - Lift tank from machine and empty the water from tank (Figure 159).

**IMPORTANT: DO NOT** add antifreeze to the automatic battery watering tank.

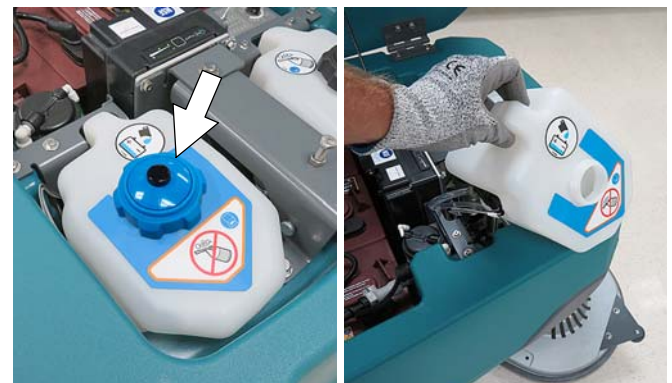

FIG. 159

6. After storing machine in freezing temperatures, drain any remaining antifreeze from the solution tank and from the optional Severe Environment detergent tank. Add clean water to solution tank and to optional detergent tank and operate the machine and spray nozzle to flush system.
7. Refill the automatic battery watering tank with distilled water, if equipped.

# MAINTENANCE

## TROUBLESHOOTING

PROBLEM	CAUSE	SOLUTION
Service indicator icon is flashing	Machine or on-board battery charger fault has been detected	See SERVICE INDICATOR CODES
ec-H2O icon is red or flashing red	ec-H2O system fault has been detected	See SERVICE INDICATOR CODES
ec-H2O icon is flashing red and blue	ec-H2O cartridge has reached maximum water usage or expiration	Replace ec-H2O cartridge
Machine will not operate	Emergency shut-off button activated	Turn button to reset
	Electronic parking brake system is disengaged (option)	See PUSHING AND TRANSPORTING MACHINE.
	Machine fault detected	See SERVICE INDICATOR CODES
	Batteries discharged	Recharge batteries
	Loose battery cable(s)	Tighten loose cables
	Faulty battery(s)	Replace battery(s)
	Faulty key switch	Contact service
	Faulty start bail switch	Contact service
	Circuit breaker tripped	Reset circuit breaker
On-board battery charger will not operate	Faulty control board	Contact service
	Plug not connected to power supply	Check plug connection
	Batteries over discharged	Replace batteries
	Battery charger fault detected	See SERVICE INDICATOR CODES
	Faulty charger	Replace charger
Machine will not propel	Faulty power supply cord	Replace power supply cord
	Propel fault has been detected	See SERVICE INDICATOR CODES
	Circuit breaker tripped (T600e)	Reset circuit breaker
	Faulty propel motor or wiring	Contact service
Brush motor will not operate	Worn carbon brushes in motor	Contact service
	Brush motor fault has been detected.	See SERVICE INDICATOR CODES
	Faulty pad motor or wiring	Contact service
	Circuit breaker tripped (T600e)	Reset circuit breaker
	Worn carbon brushes in motor	Contact service
Vacuum motor will not operate	Broken or loose belt (cylindrical brush model)	Contact service
	Squeegee assembly is raised off floor	Lower squeegee assembly to floor
	Vacuum motor fault has been detected	See SERVICE INDICATOR CODES
	Faulty vacuum motor or wiring	Contact service
Poor scrubbing performance	Circuit breaker tripped	Reset circuit breaker
	Debris caught in brush/pad	Remove debris
	Worn brush/pad	Replace brush/pad
	Incorrect brush pressure	Adjust brush pressure
	Wrong brush/pad type	Use correct brush/pad for application
	Low battery charge	Recharge batteries
	Uneven brush pressure	Scrub head/brushes not level. Contact service
Broken or loose belt (cylindrical brush model)	Contact service	

**TROUBLESHOOTING - Continued**

<b>PROBLEM</b>	<b>CAUSE</b>	<b>SOLUTION</b>
Trailing water - poor or no water pickup	Full recovery tank or excessive foam buildup	Drain recovery tank
	Loose drain hose cap or flow control valve is open	Replace cap or close flow control valve on drain hose
	Worn squeegee blades	Rotate or replace squeegee blades
	Clogged drip trap (Squeegee assembly)	Remove cover and clean
	Clogged squeegee assembly	Clean squeegee assembly
	Loose vacuum hose connection	Secure vacuum hose connection
	Clogged vacuum hose	Flush vacuum hose
	Damaged vacuum hose	Replace vacuum hose
	Clogged float shut-off screen in recovery tank	Clean screen
	Recovery tank lid not completely closed	Check lid for obstructions
	Defective seals on recovery tank lid	Replace seal
Little or no solution flow	Empty solution tank	Refill solution tank
	Low solution flow rate set	Increase solution flow rate
	Clogged solution tank filter	Clean filter
	Plugged solution supply line	Flush solution supply line
Severe environment tank does not dispense detergent	No detergent	Refill tank
	Faulty float switch	Contact service
	Defective pump	Contact service
	Defective pump potentiometer	Contact service
	Faulty control panel	Contact service
Automatic battery watering tank does not dispense water	Tank is empty	Refill tank
	Defective pump	Contact service
	Pump not priming	Contact service
	Faulty control board	Contact service
Short run time	Low battery charge	Charge batteries
	Batteries need maintenance	See BATTERIES
	Defective battery or end of battery life	Replace batteries
	Battery discharge indicator (BDI) programmed incorrectly	See CHARGING BATTERIES
	Faulty charger	Replace battery charger
	Brush pressure set too high	Lower brush pressure
Solution tank auto-fill does not function properly	Coupler not properly connected	Connect coupler
	Faulty shut-off float	Replace float. Contact service
	Machine not on level surface	Machine must be on level surface
Excessive scrub head noise (Orbital model)	Damaged scrub head isolators	Replace isolators. Contact service

# SPECIFICATIONS

## GENERAL MACHINE DIMENSIONS/CAPACITIES/PERFORMANCE

MODEL	28 in / 700 mm Disk	32 in / 800 mm Disk	36 in / 900 mm Disk
Length	63.7 in / 1617 mm	65.8 in / 1671 mm	69.3 in / 1761 mm
Width	30.1 in / 764 mm	33.7 in / 865 mm	37.6 in / 955 mm
Height	43.6 in / 1107 mm	43.6 in / 1107 mm	43.6 in / 1107 mm
Weight (less batteries)	463 lb / 210 kg	466 lb / 212 kg	470 lb / 214 kg
Weight (with batteries)	1033 lb / 470 kg	1036 lb / 471 kg	1040 lb / 473 kg
GVW	1301 lb / 591 kg	1304 lb / 593 kg	1308 lb / 595 kg
Solution tank capacity	32 gal / 121 L		
Recovery tank capacity	37 gal / 140 L		
Severe Environment tank capacity	1.1 gal / 4 L		
Automatic battery watering tank capacity	1.1 gal / 4 L		
Scrubbing path width	28 in / 700 mm	32 in / 800mm	36 in / 900 mm
Squeegee width	38.3 in / 973 mm	41.3 in / 1049 mm	46.6 in / 1234 mm
Down pressure (T600e)	Low: 150 lbs / 68 kg, High: 200 lbs / 90 kg		
Down pressure (T600)	Low: 100 lbs / 45 kg, Med: 150 lbs / 68 kg, High: 200 lbs / 90 kg		
Down pressure (T600e Heavy Duty down pressure model)	n/a	Low: 150 lbs / 68 kg, High: 200 lbs / 90 kg Heavy Duty: 300 lbs / 136 kg	n/a
Down pressure (T600 Heavy Duty down pressure model)	n/a	Low: 100 lbs / 45 kg, Med: 150 lbs / 68 kg, High: 200 lbs / 90 kg Heavy Duty: 300 lbs / 136 kg	n/a
Scrubbing speed, variable	3.0 mph / 4.8 km/h (260 fpm / 79 mpm)		
Transport speed, variable	3.3 mph / 5.3 km/h (290 fpm / 88 mpm)		
Reverse speed, variable	1.6 mph / 2.6 km/h (140 fpm / 43 mpm)		
Aisle turnaround width	65 in / 1650 mm	67 in / 1700 mm	70 in / 1775 mm
Tires	12.6 in / 320 mm solid, non-marking (Standard)		
	12.6 in / 320 mm foamed-fill, 12.6 in / 320 mm pneumatic (Pressure: 60-65 psi / 415-450 kPa)		
Productivity rate - estimated actual	24,005 ft <sup>2</sup> /hr / 2230 m <sup>2</sup> /hr	27,698 ft <sup>2</sup> /hr / 2573 m <sup>2</sup> /hr	31,391 ft <sup>2</sup> /hr / 2916 m <sup>2</sup> /hr
ec-H <sub>2</sub> O productivity rate - est. actual	28,863 ft <sup>2</sup> /hr / 2681 m <sup>2</sup> /hr	33,304 ft <sup>2</sup> /hr / 3094 m <sup>2</sup> /hr	34,964 ft <sup>2</sup> /hr / 3248 m <sup>2</sup> /hr
Maximum operating gradient	2%		
Solution flow rate	Low: .50 gpm / 1.89 L/min, Med: .75 gpm / 2.84 L/min, High: 1.0 gpm / 3.78 L/min		
ec-H <sub>2</sub> O solution flow rate	Low: .22 gpm / 0.83 L/min, Med: .33 gpm / 1.25 L/min, High: .44 gpm / 1.66 L/min		
Brush motor (T600e)	2-36 VDC, 0.75 hp/0.56 kW, 22 A, 200 rpm		
Brush motor (T600)	2-36 VDC, 1.00 hp/0.75 kW, 30 A, 300 rpm		
Brush actuator motor (T600e)	36 VDC		
Brush actuator motor (T600)	36 VDC		
Propel motor	36 VDC, 0.5 hp 380 W, 12.6 A		
Vacuum motor	36 VDC, 0.75 hp / .56 kW, 15.6 A		
Water lift	50 in / 1270 mm		
ec-H <sub>2</sub> O solution pump	36 VDC, 5 A, 1.5 gpm / 5.7 L/min, min open flow		
Severe environment detergent pump (T600)	24 VDC, 2.0 oz/min / .06 L/min, max open flow		
Automatic battery watering pump	12 VDC, 4 A, 0.9 gpm / 3.5 L/min, min open flow		
Spray nozzle pump (T600)	36 VDC, 2.3 A, 4.9 gpm / 18.5 L/min, max open flow		
Machine voltage	36 VDC		
Battery capacity	6-6V 240AH C/20 Wet, 6-6V 360AH C/20 Wet, 3-12V 186AH C/6 TPPL		
Total power consumption	50 A nominal / 1.8 kW		
Battery Charger - on-board (global)	100-240VAC, 50/60Hz, 36VDC, 25A		
Battery Charger - on-board, TPPL	100-240VAC, 50/60Hz, 36VDC, 33A		
Battery Charger - off-board (Smart)	100-240VAC, 50/60Hz, 36VDC, 25A		
Protection grade	IPX3		
Sound pressure level L <sub>pA</sub> *	69.5 dB(A)		
Sound pressure level L <sub>pA</sub> * - Quiet mode	62.2 dB(A)		
Sound uncertainty K <sub>pA</sub> *	3 dB(A)		
Sound power level uncertainty L <sub>pA</sub> - uncertainty K <sub>pA</sub> *	72.5 dB(A)		
Machine vibration at hand-arm*	<2.5 m/s <sup>2</sup>		
Ambient operating temperature	Min: 36°F/2°C, Max: 110°F/43°C		

\*Values per IEC 60335-2-72. Specifications are subject to change without notice.

**GENERAL MACHINE DIMENSIONS/CAPACITIES/PERFORMANCE - Continued**

<b>MODEL</b>	<b>28 in / 700 mm Cylindrical</b>	<b>32 in / 800 mm Cylindrical</b>	<b>28 in / 700 mm Orbital</b>
Length	64.4 in / 1637 mm	64 in / 1625 mm	62.6 in / 1590 mm
Width	31.2 in / 792 mm	35.1 in / 892 mm	29.4 in / 746 mm
Height	43.6 in / 1107 mm	43.6 in / 1107 mm	43.6 in / 1107 mm
Weight (less batteries)	479 lb / 218 kg	482 lb / 219 kg	489 lb / 222 kg
Weight (with batteries)	1049 lb / 477 kg	1052 lb / 478 kg	1059 lb / 481 kg
GVW	1317 lb / 599 kg	1320 lb / 600 kg	1327 lb / 603 kg
Solution tank capacity	32 gal / 121 L		
Recovery tank capacity	37 gal / 140 L		
Severe Environment tank capacity	1.1 gal / 4 L		
Automatic battery watering tank capacity	1.1 gal / 4 L		
Scrubbing path width	28 in / 700 mm	32 in / 800mm	28 in / 700 mm
Squeegee width	38.3 in / 973 mm	41.3 in / 1049 mm	38.3 in / 973 mm
Down pressure (T600e)	Low: 50 lbs / 23 kg High: 90 lbs / 41 kg		Low: 105 lbs / 48 kg High: 170 lbs / 77 kg
Down pressure (T600)	Low: 50 lbs / 23 kg Med: 70 lbs / 32 kg High: 90 lbs / 41 kg		Low: 105 lbs / 48 kg Med: 135 lbs / 61 kg High: 170 lbs / 77 kg
Scrubbing speed, variable	3.0 mph / 4.8 km/h (260 fpm / 79 mpm)		
Transport speed, variable	3.3 mph / 5.3 km/h (290 fpm / 88 mpm)		
Reverse speed, variable	1.6 mph / 2.6 km/h (140 fpm / 43 mpm)		
Aisle turnaround width	67 in / 1700 mm	67.5 in / 1713 mm	60 in / 1540 mm
Tires	12.6 in / 320 mm solid, non-marking (Standard)		
	12.6 in / 320 mm foamed-fill, 12.6 in / 320 mm pneumatic (Pressure: 60-65 psi / 415-450 kPa)		
Productivity rate - estimated actual	24,005 ft <sup>2</sup> /hr / 2230 m <sup>2</sup> /hr	27,698 ft <sup>2</sup> /hr / 2573 m <sup>2</sup> /hr	24,005 ft <sup>2</sup> /hr / 2230 m <sup>2</sup> /hr
ec-H <sub>2</sub> O productivity rate - est. actual	28,863 ft <sup>2</sup> /hr / 2681 m <sup>2</sup> /hr	33,304 ft <sup>2</sup> /hr / 3094 m <sup>2</sup> /hr	28,863 ft <sup>2</sup> /hr / 2681 m <sup>2</sup> /hr
Maximum operating gradient	2%		
Solution flow rate	Low: .50 gpm / 1.89 L/min, Med: .75 gpm / 2.84 L/min, High: 1.0 gpm / 3.78 L/min		
ec-H <sub>2</sub> O solution flow rate	Low: .22 gpm / 0.83 L/min, Med: .33 gpm / 1.25 L/min, High: .44 gpm / 1.66 L/min		
Brush motor (T600e)	2-36 VDC, 0.9 hp/0.67 kW, 22 A, 1800 rpm Brush speed: 760 rpm		36 VDC, 0.75 hp/0.56 kW, 18.5 A, 2200 rpm
Brush motor (T600)	2-36 VDC, 0.9 hp/0.67 kW, 22 A, 1800 rpm Brush speed: 760 rpm		36 VDC, 0.75 hp/0.56 kW, 18.5 A, 2200 rpm
Brush actuator motor (T600e)	36 VDC		
Brush actuator motor (T600)	36 VDC		
Propel motor	36 VDC, 0.5 hp / 380 W, 12.6 A		
Vacuum motor	36 VDC, 0.75 hp / .56 kW, 15.6 A		
Water lift	50 in / 1270 mm		
ec-H <sub>2</sub> O solution pump	36 VDC, 5 A, 1.5 gpm / 5.7 L/min, min open flow		
Severe environment detergent pump (T600)	24 VDC, 2.0 oz/min / .06 L/min, max open flow		
Automatic battery watering pump	12 VDC, 4 A, 0.9 gpm / 3.5 L/min, min open flow		
Spray nozzle pump (T600)	36 VDC, 2.3 A, 4.9 gpm / 18.5 L/min, max open flow		
Machine voltage	36 VDC		
Battery capacity	6-6V 240AH C/20 Wet, 6-6V 360AH C/20 Wet, 3-12V 186AH C/6 TPPL		
Total power consumption	50 A nominal / 1.8 kW		
Battery Charger - on-board (global)	100-240VAC, 50/60Hz, 36VDC, 25A		
Battery Charger - on-board, TPPL	100-240VAC, 50/60Hz, 36VDC, 33A		
Battery Charger - off-board (Smart)	100-240VAC, 50/60Hz, 36VDC, 25A		
Protection grade	IPX3		
Sound pressure level L <sub>pA</sub> *	69.2 dB(A)		69.5 dB(A)
Sound pressure level L <sub>pA</sub> * - Quiet mode	62.2 dB(A)		62.3 dB(A)
Sound uncertainty K <sub>pA</sub> *	3 dB(A)		
Sound power level uncertainty L <sub>pA</sub> - uncertainty K <sub>pA</sub> *	72.2 dB(A)		72.5 dB(A)
Machine vibration at hand-arm*	<2.5 m/s <sup>2</sup>		
Ambient operating temperature	Min: 36°F/2°C, Max: 110°F/43°C		

\*Values per IEC 60335-2-72. Specifications are subject to change without notice.

# SPECIFICATIONS

## MACHINE DIMENSIONS

### DISK MODEL

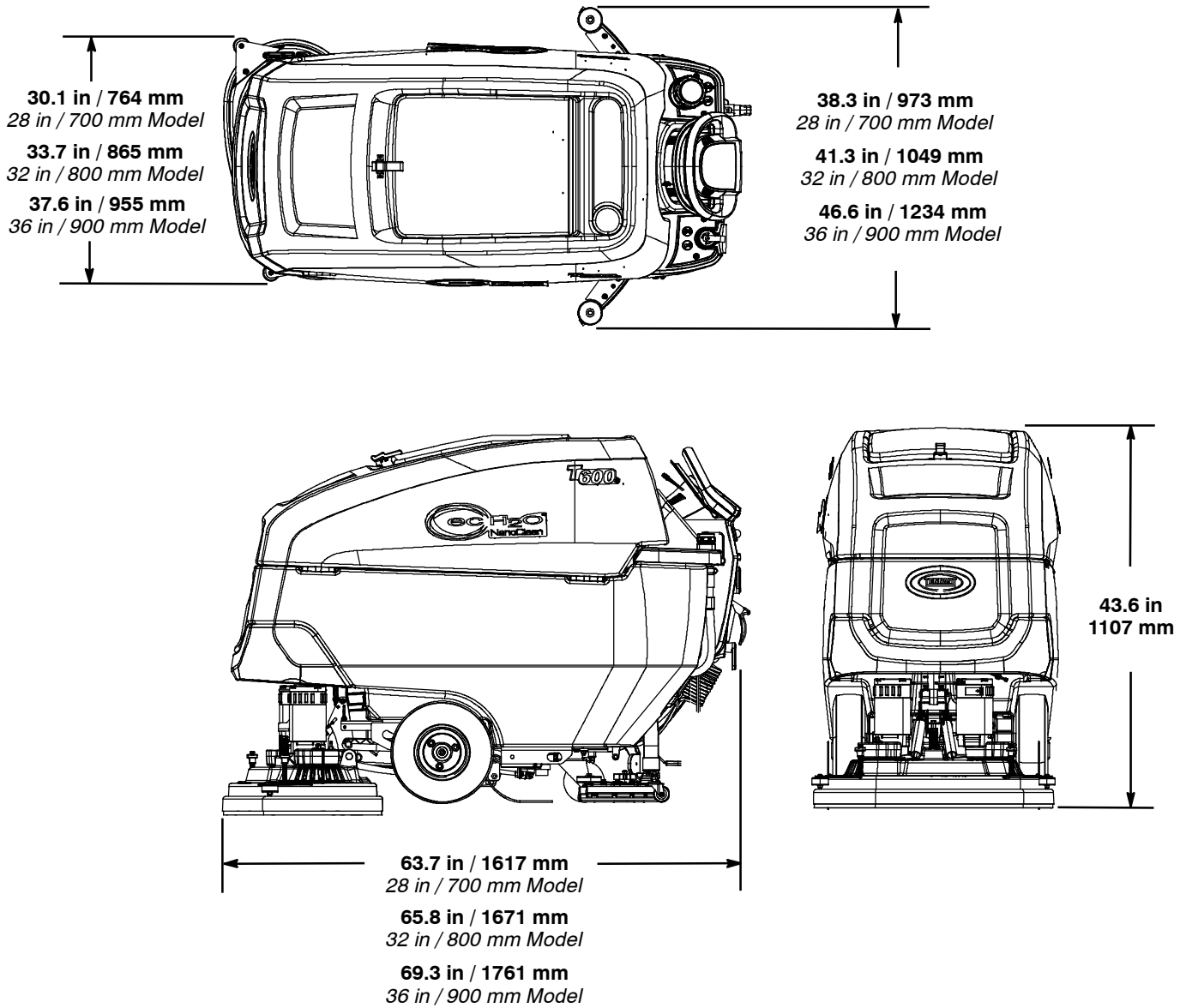



**CYLINDRICAL BRUSH MODEL**

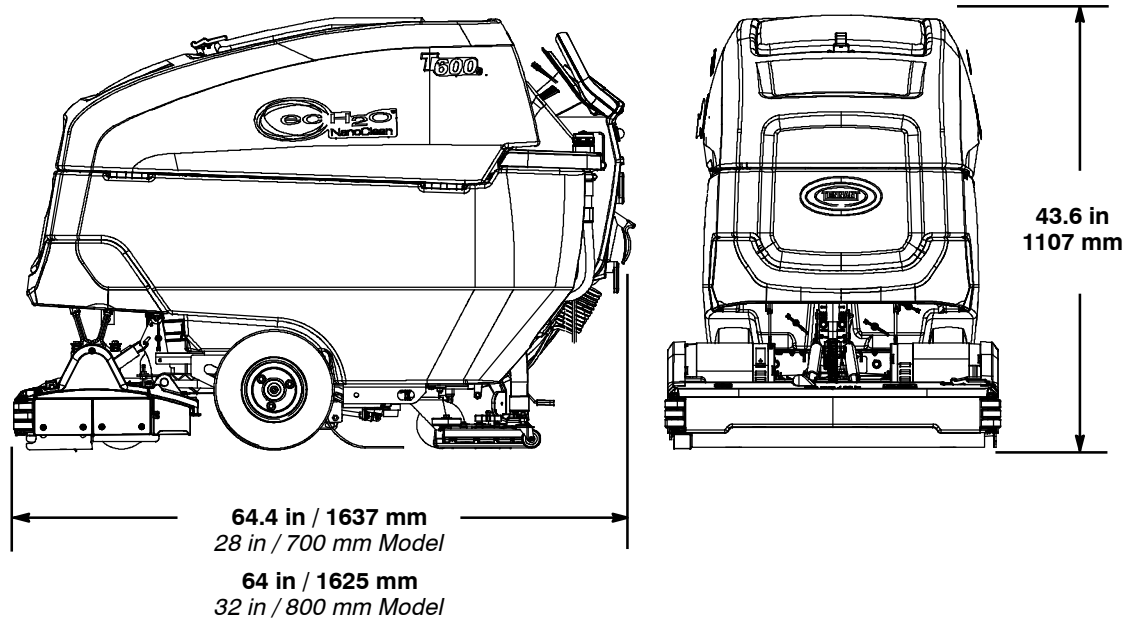
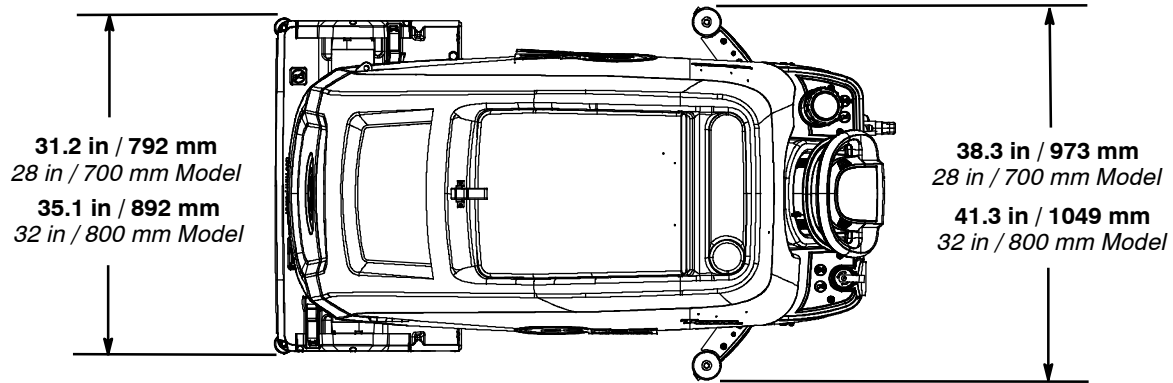

# SPECIFICATIONS

---

## ORBITAL PAD MODEL

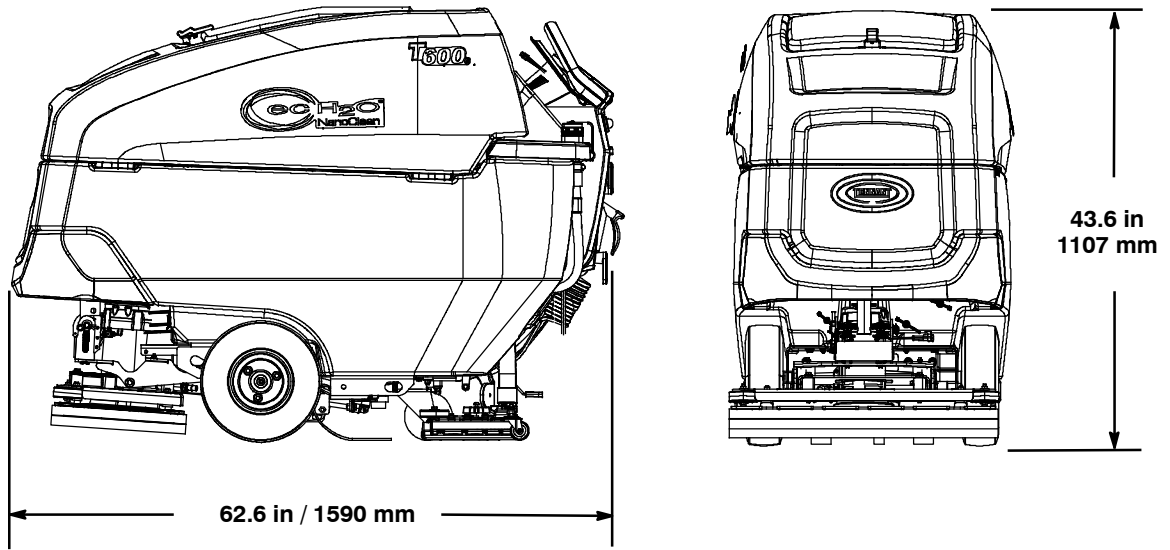
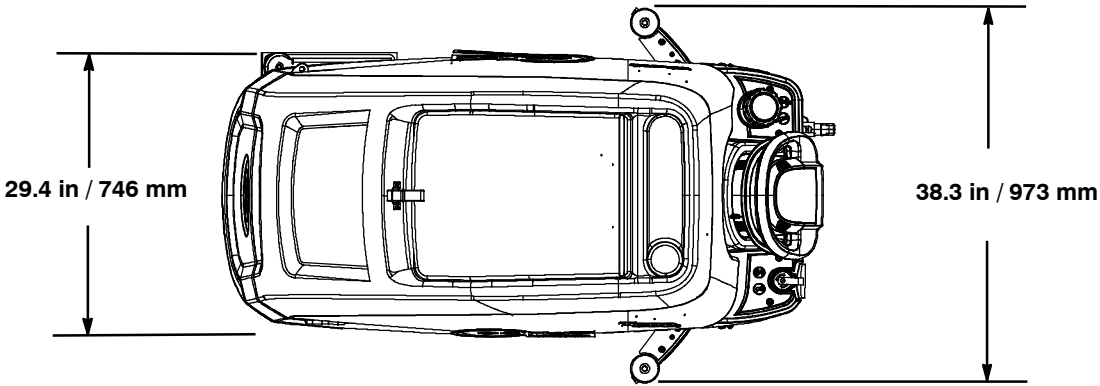

**SUPERVISOR CONTROLS**

**ATTENTION:** The following instructions are intended for supervisor use only. Remove pages from manual if necessary.

The supervisor controls feature allows a supervisor to program the machine's scrubbing settings for operator use. The lockout functionality will prevent the operator from changing or saving scrub settings.

The supervisor controls feature will lower machine variability for consistent, repeatable cleaning results, provide machine quality assurance regardless of user experience, and reduce user training requirements.

**T600e MODEL**

The machine has two supervisor control modes of operation to choose from:

**Unlocked Mode 1:** Operator has ability to use full range of brush pressure and solution flow settings. The Unlocked Mode 1 is the factory default setting.

**Lockout Mode 2:** Maximum limits for brush pressure and solution flow settings are preset and locked by supervisor.

**Entering the Supervisor Control Modes**

1. Park the machine on a level surface and turn the key to off ( O ) position.
2. Press and hold the brush pressure button while turning the key on. Release button when the far right battery discharge indicator LED turns on (Figure 160).

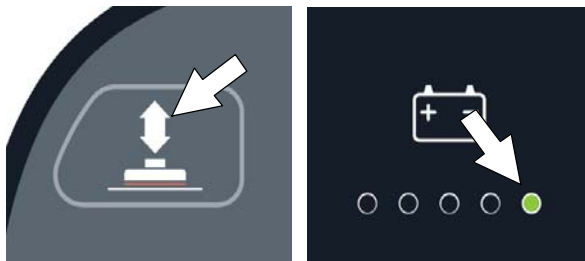

**FIG. 160**

The active mode setting will be displayed by a LED as described below (Figure 161),

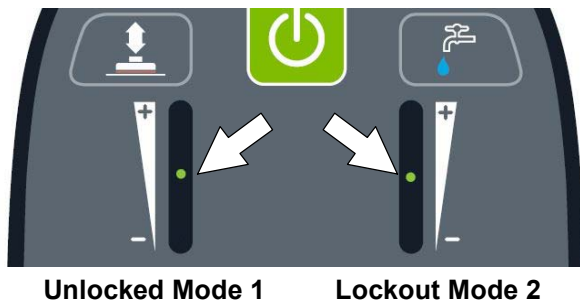

**FIG. 161**

3. Press the brush pressure button to toggle between the two modes (Figure 162). The LED of the selected mode will blink until saved.

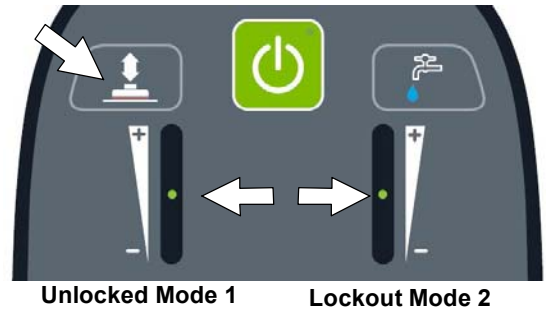

**FIG. 162**

4. To save the selected mode, press and hold the brush pressure button and the solution flow button together until the LED turns solid, approximately 3 seconds (Figure 163).

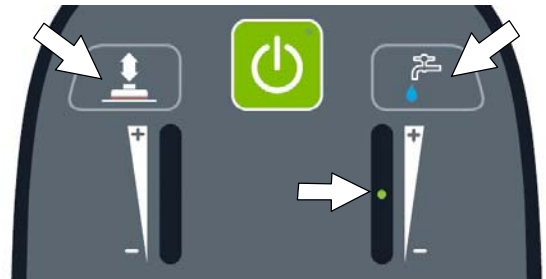

**FIG. 163**

5. If Lockout Mode 2 was selected, press the solution flow button then choose the desired maximum limits for the solution flow and the brush pressure settings (Figure 164).



**FIG. 164**

6. To save the desired maximum limits, press and hold the brush pressure button and the solution flow button together until the LED turns solid, approximately 3 seconds (Figure 165).

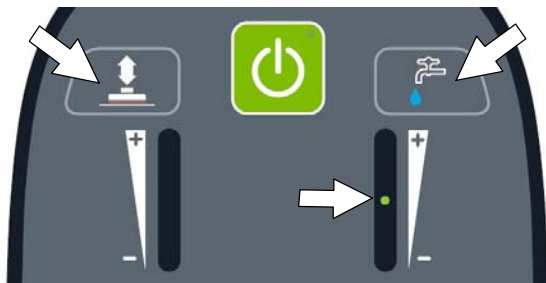

**FIG. 165**

7. To exit the supervisor control mode, turn key off.

# SUPERVISOR CONTROLS

## T600 PRO-MEMBRANE CONTROL PANEL MODEL

The machine has three supervisor control modes of operation to choose from:

**Unlocked Mode 1:** Operator has full control of all scrubbing parameters with the ability to reconfigure the preset zone control buttons. The Unlocked Mode 1 is the factory default setting.

**Lockout Mode 2:** Zone control buttons are preset and locked by supervisor. Operator has the ability to reconfigure the preset zone control buttons, but are not able to save them.

**Lockout Mode 3:** Zone control buttons are preset and locked by supervisor. Operator is restricted to only use the zone control buttons preset by supervisor.

### Entering the Supervisor Control Modes

1. Park the machine on a level surface and turn the key to off ( O ) position.
2. Press and hold the brush pressure button while turning the key on. Release button when the far right battery discharge indicator LED turns on (Figure 166). After releasing button, the active supervisor control mode will display as described in step 3 (Figure 167),

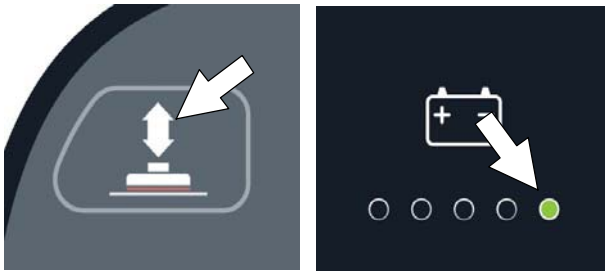

FIG. 166

3. To select or change a supervisor control mode, press and hold the specific zone control button until the LED blinks three times (Figure 167). For lockout mode 3, press and hold zone control buttons 1 and 2 at same time. After selection is made, the LED will turn solid to indicate new mode.

Unlocked mode 1 = Zone control button 1  
 Lockout mode 2 = Zone control button 2  
 Lockout mode 3 = Zone control buttons 1 & 2

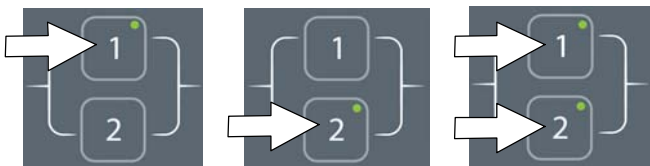

FIG. 167

4. Press the solution flow button to configure the zone control button presets for lockout modes 2 or 3 (Figure 168).



FIG. 168

5. Configure the zone control button presets from list below, then press and hold zone control button until it blinks three times to save preset. Repeat process for other two zones. To preset zone control 3, press zone control buttons 1 and 2 at the same time.

Zone control presets:

- Brush pressure rate
- Solution flow rate
- Quiet-Mode button on or off
- ec-H2O mode switch on or off
- Severe Environment button on or off (Hold button for 3 seconds until LED turns on)
- Maximum scrubbing speed setting

To adjust the maximum scrub speed setting, press the severe environment button to cycle through the five speed selections as described below (Figure 169). For models without the severe environment button, press area on panel as shown. The button is hidden.

The speed selection is displayed by the battery discharge indicator LEDs. The red LED represents the lowest speed. The far right green LED represents the highest speed (Figure 169).

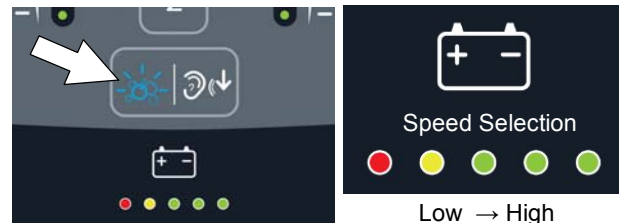

FIG. 169

*NOTE: The maximum scrub speed setting can only be adjusted in supervisor control lockout modes 2 and 3.*

6. To exit the supervisor control mode, turn key off.

**T600 PRO-PANEL CONTROLS MODEL**

There are two types of user modes that will interface with the home screen.

**Operator Mode** - Capable of machine operation with permissions and restrictions controlled by the supervisor. The operator mode home screen restricts access to the machine settings button and maximum scrub speed button (Figure 170).



FIG. 170

**Supervisor Mode** - Capable of machine operation with full use of all controls, along with configuring permissions and restrictions for the operator mode and login capability. The supervisor mode home screen provides access to the machine settings button and to the maximum scrub speed button (Figure 171).

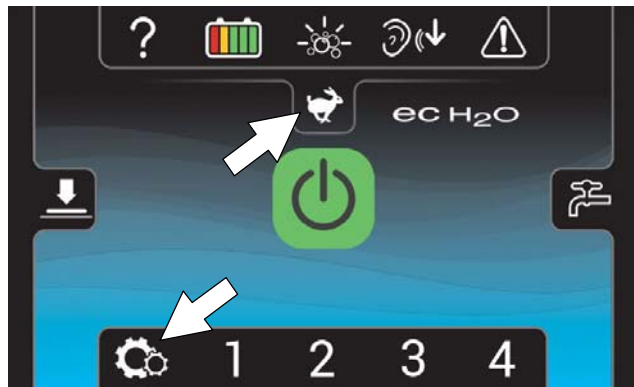

FIG. 171

A new machine from the factory will automatically start up in the supervisor mode with a preassigned default supervisor profile. The machine's factory-assigned supervisor login code is "1234". This login code is not required until it is enabled. The default supervisor profile name and login code can be changed as described in this section. If the new assigned supervisor mode login code is forgotten, use the recovery login code 836626826.

**Entering the Supervisor Mode -**

1. Turn on the machine. The home screen will display at start up (Figure 172). Press the help button.



FIG. 172

2. Press the login button (Figure 173).

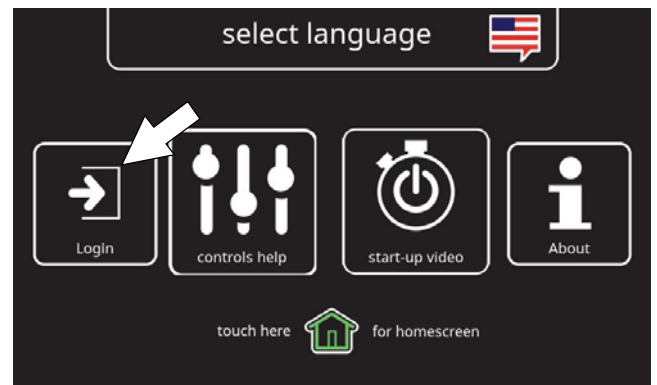

FIG. 173

3. First time use - Enter the factory-assigned supervisor mode login code "1234" then press the green enter button (Figure 174).

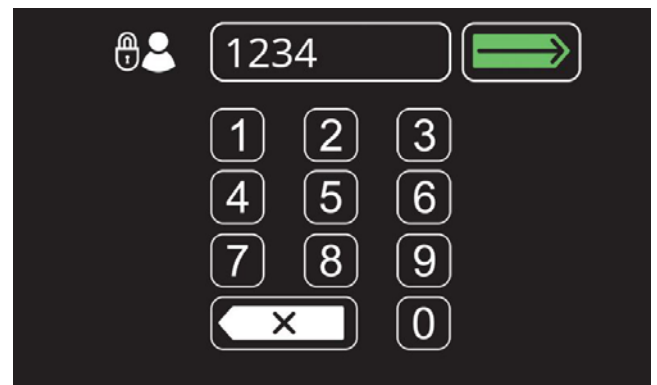

FIG. 174

## SUPERVISOR CONTROLS

- The supervisor mode home screen will appear (Figure 175). Press the machine settings button.



FIG. 175

- The machine's setting screen provides access to the following menu (Figure 176).

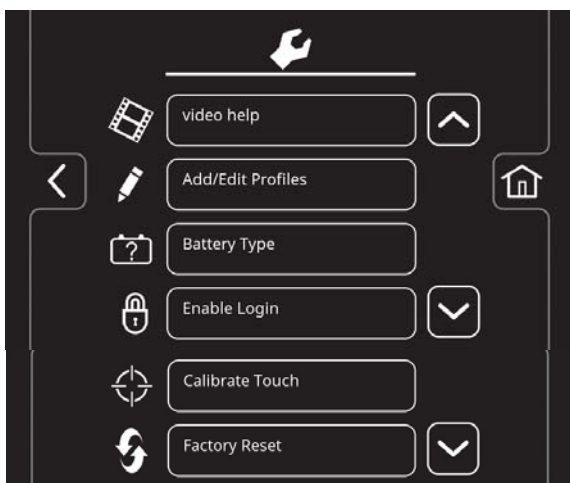







FIG. 176

 **Video help** - Use to view specific operation and maintenance procedures.

 **Add/Edit Profiles** - Use to add/edit user profiles for machine use.

 **Battery Type** - Use to configure the machine for different battery types. See BATTERIES.

 **Enable Login** - Use to activate a required login code at machine start up to operate machine.

 **Calibrate Touch** - Use this to recalibrate the touch screen if the touch points become misaligned.

 **Factory Reset** - Resets the supervisor login code back to the factory default code "1234", removes user profiles and resets any custom preset zone control buttons back to the factory preset zones.

### To Add/Edit User Profiles

- Press the Add/Edit Profiles button to enter a new user profile (Figure 177).

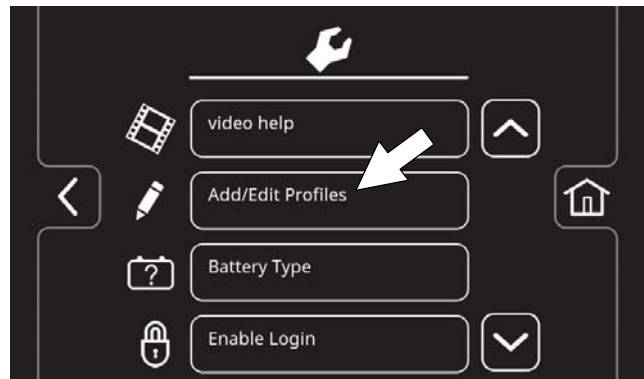

FIG. 177

- Press the Add Profile button to add a new user profile (Figure 178).

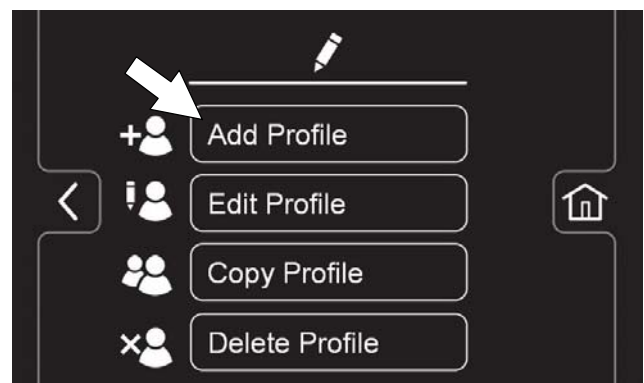



FIG. 178

Use the edit, copy and delete profile buttons to manage the current user profiles.

 Press to edit an existing user profile

 Press to copy an existing user profile

 Press to delete a user profile

3. Press the Operator button to add an Operator mode profile or press the Supervisor button to add an additional supervisor mode profile (Figure 179).

*Note: The machine's default supervisor profile can not be deleted from profile list.*

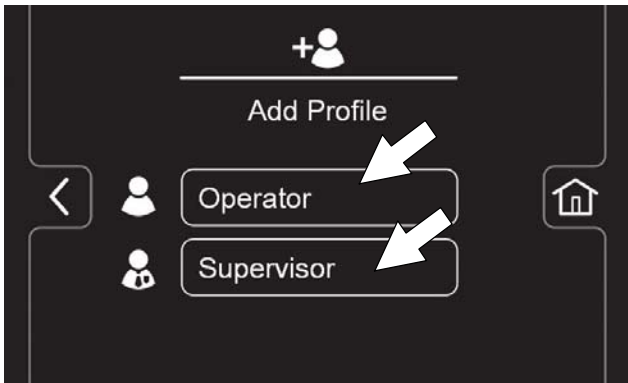

**FIG. 179**

4. Enter the name of the new user profile then press the green enter button (Figure 180).



**FIG. 180**

5. Assign a login code for the new user profile then press the green enter button (Figure 181). The new login code can be any combination of numbers ranging from 3 to 8 digits in length.



**FIG. 181**

6. Select the controls the new user should only have access to use (Figure 182). Green represents unlocked controls and gray represents locked controls. Press the flashing save button to save new profile.

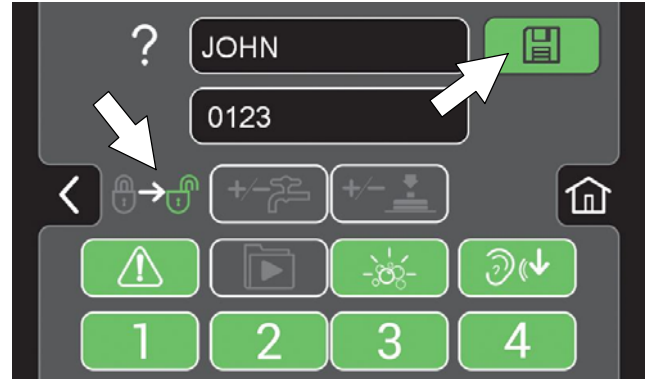

**FIG. 182**

7. The new user profile is now saved to the operator profile list as shown (Figure 183). Multiple Operator and Supervisor user profiles can be added. Press the back arrow to return to the previous screen to add more user profiles.

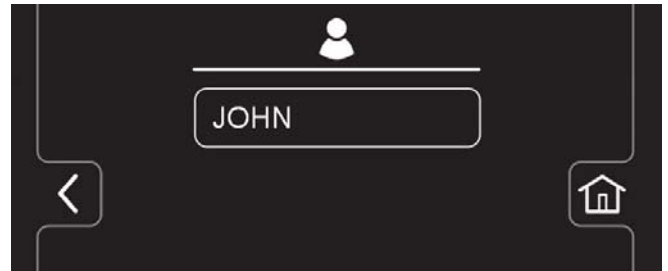

**FIG. 183**

8. To enable the login screen at start up (Figure 184), see Enabling the Login.

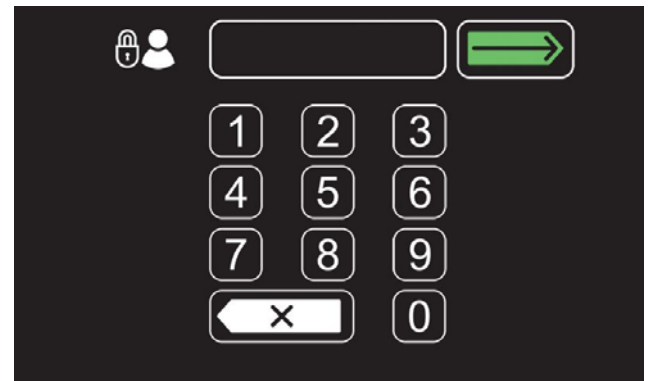

**FIG. 184**

# SUPERVISOR CONTROLS

## Enabling the Login Screen

1. Turn on the machine.
2. Press the help button and log into the machine as supervisor mode (Figure 185). See *Entering the Supervisor Mode*.

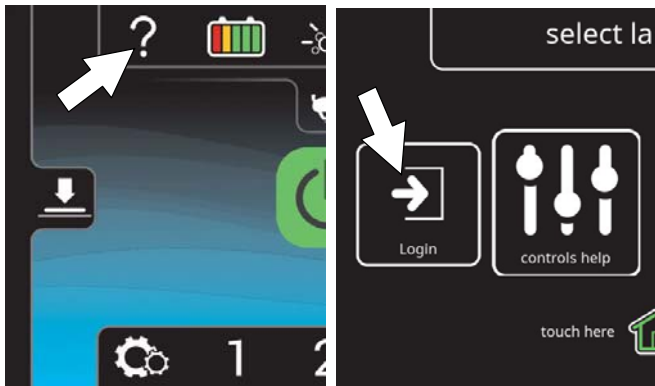

FIG. 185

3. Press the machine settings button (Figure 186).



FIG. 186

4. Press the Enable Login button (Figure 187). The Enable button will change from Enable Login to Disable Login.

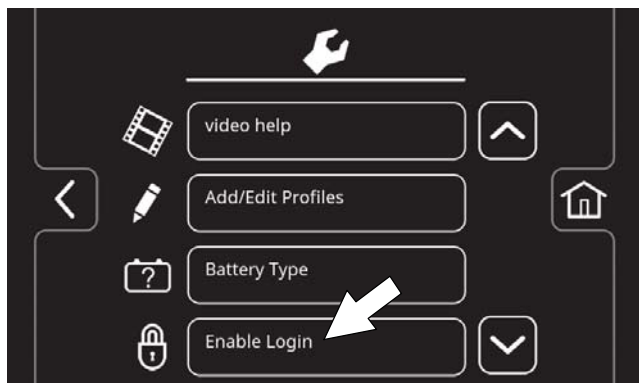

FIG. 187

5. Press the yes button to enable login (Figure 188).



FIG. 188

6. Now at machine start up, the login screen will display (Figure 189). The user will need to enter their assigned login code to operator machine.

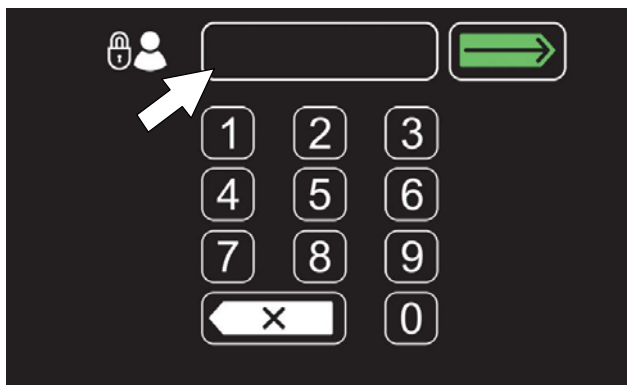

FIG. 189

7. When the user is done operating the machine, it is recommended the user log out by pressing the help button, and then pressing the logout button (Figure 190). Turning the key to the off position is another way to also logout

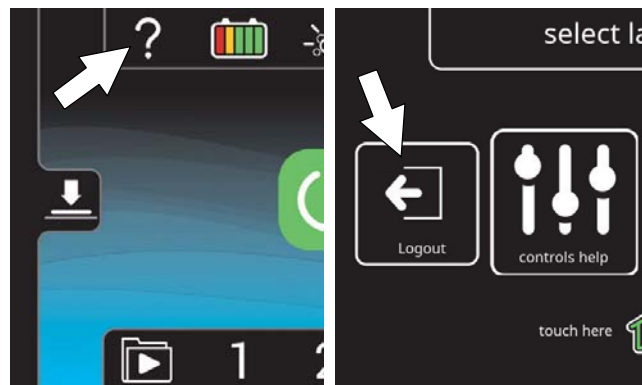

FIG. 190



**Disabling the Login Screen**

1. Turn on the machine.
2. Press the help button and log into the machine as supervisor mode (Figure 191). See *Entering the Supervisor Mode*.

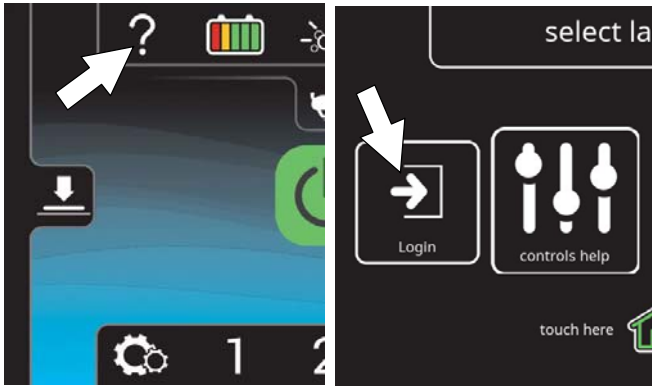

FIG. 191

3. Press the machine settings button (Figure 192).



FIG. 192

4. Press the Disable Login button (Figure 193).

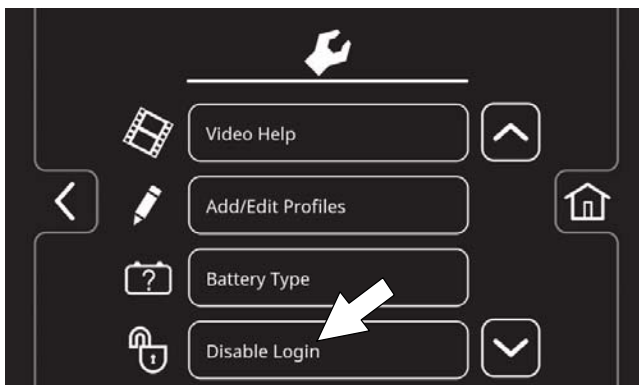

FIG. 193

5. Press the yes button to disable the login at machine start up (Figure 194).



FIG. 194

6. Press either the Operator button or Supervisor button to select desired user profile as your home screen default without login (Figure 195).

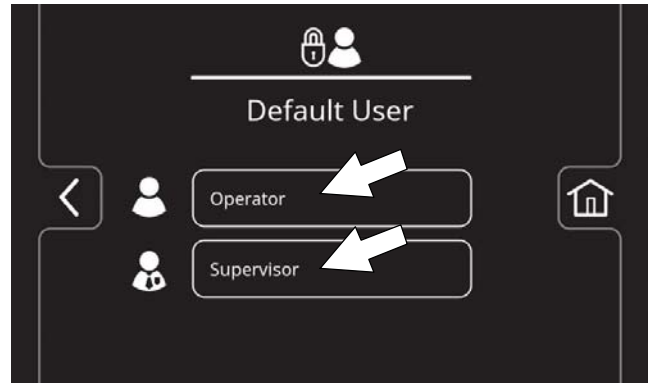

FIG. 195

7. Select a pre-assigned user profile. In this example, operator profile "JOHN" is selected (Figure 196). Turn the key off to apply the setting.

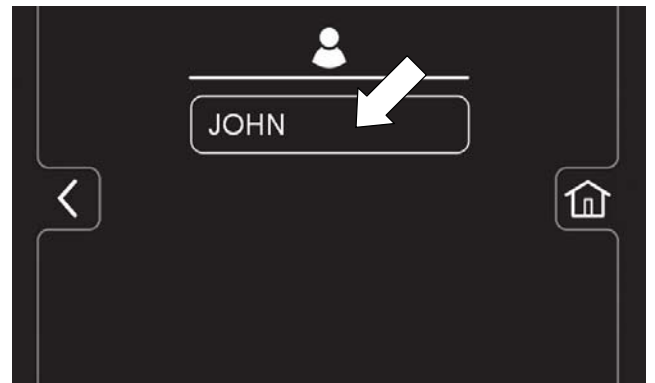

FIG. 196

8. At start up, the home screen is now set for the desired user profile as the default without login.

**NOTE:** To change to a different user profile as the default home screen without login, you must re-enable login and repeat the disabling login instructions.

# SUPERVISOR CONTROLS

## Changing the Factory-Assigned Supervisor Login Code

1. Press the machine's setting button (Figure 197)



FIG. 197

2. Press the Add/Edit Profiles button (Figure 198).

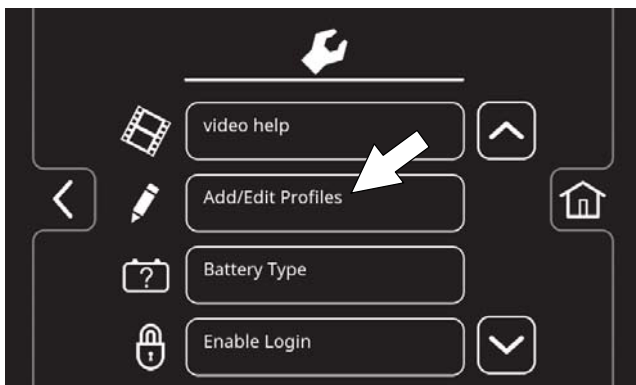

FIG. 198

3. Press the Edit Profile button (Figure 199).

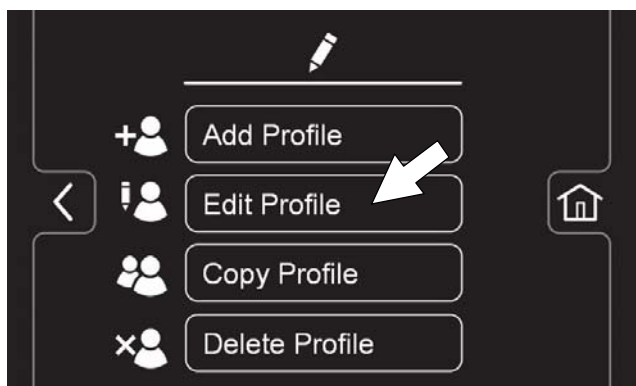

FIG. 199

4. Press the Supervisor button then press the DEFAULT SUPER button (Figure 200 ).

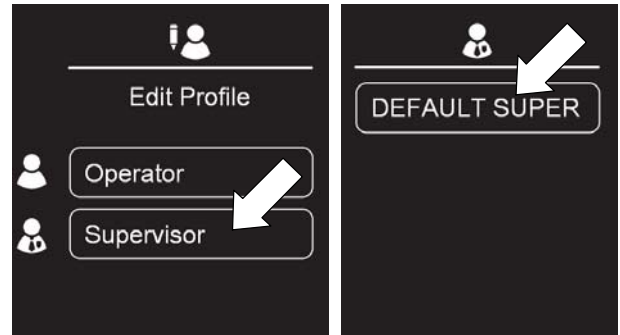

FIG. 200

5. Press the factory-assigned login code and enter a new login code (Figure 201). Press the flashing save button to save the new login code.

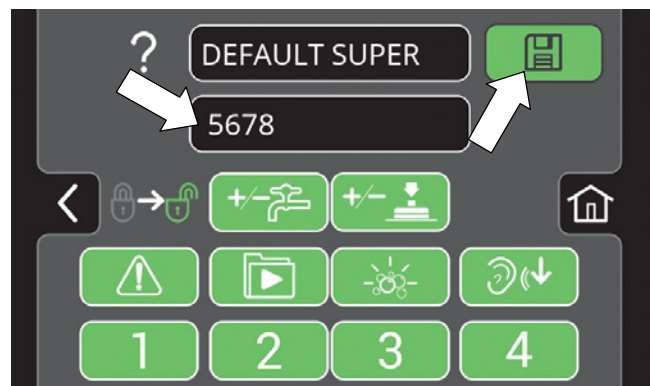

FIG. 201

